

MULTILINER®
SESAM ROOFS - The ultimate collection

TIRLINER®
SESAM ROOFS - The ultimate collection

1- Sliding roof - Tirliner: folding plates 500mm

Article	Description	5855mm	6450mm	7045mm	7640mm	8235mm	8830mm	9425mm	10020mm	10615mm	11210mm	11805mm	12400mm	12995mm	13590mm
192.28.2550	Assembled roofstick 2550mm Multi	13	14	15	16	17	18	19	20	21	22	23	24	25	26
210.28.2550	Moving part 2550mm Multi	1	1	1	1	1	1	1	1	1	1	1	1	1	1
200.28.2550	Box section 120*40*2550 Multi	1	1	1	1	1	1	1	1	1	1	1	1	1	1
194.25.8501	TIR folding plate L=492mm	24	26	28	30	32	34	36	38	40	42	44	46	48	50
194.25.8401	TIR folding plate L=392mm	2	2	2	2	2	2	2	2	2	2	2	2	2	2
8925	Opening handle L=2400mm	1	1	1	1	1	1	1	1	1	1	1	1	1	1
235.34.0070	Kit accessories Highliner 2002	1	1	1	1	1	1	1	1	1	1	1	1	1	1
235.25.0002	TIR packet	1	1	1	1	1	1	1	1	1	1	1	1	1	1
235.34.0004	TIR packet side curtain rollers	1	1	1	1	1	1	1	1	1	1	1	1	1	1

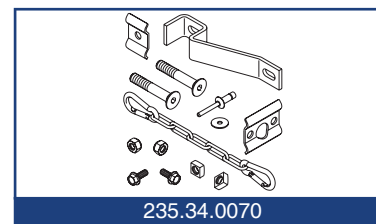
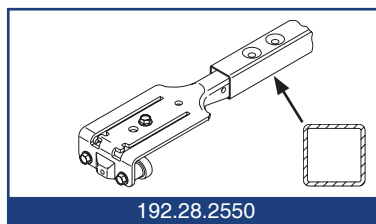
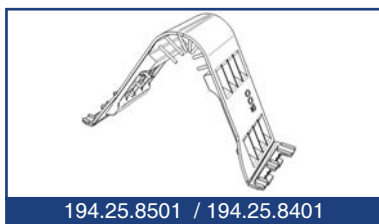

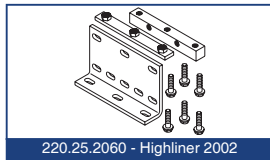

220.25.2060 - Highliner 2002

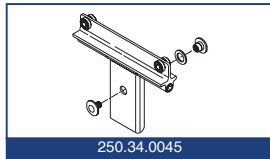
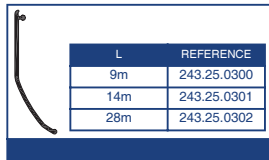

250.34.0045

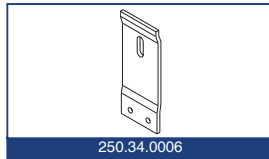

250.34.0006

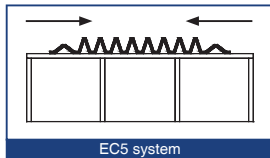

EC5 system

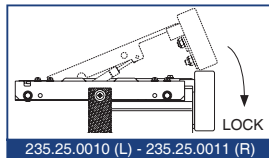

235.25.0010 (L) - 235.25.0011 (R)

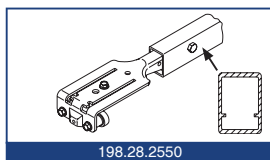

198.28.2550

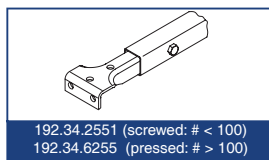

192.34.2551 (screwed: # < 100)
192.34.6255 (pressed: # > 100)

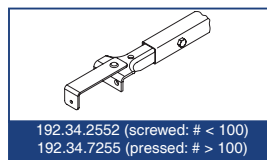

192.34.2552 (screwed: # < 100)
192.34.7255 (pressed: # > 100)

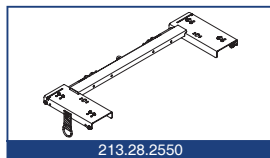

213.28.2550

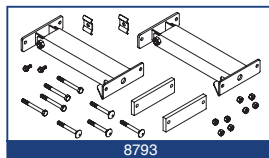

8793

2-Accessories

Article	Description
243.25.0301	Multi rubber pelmet 14m - black (grey & white available)
220.25.2060	Mounting kit for Highliner 2002
250.34.0045	Alu pillar bracket incl. bolt and nut Highliner
250.34.0006	Steel plate zined for alu pillar bracket Highliner

3-Options

Article	Description
209.28.2550	EC5 opening for Multi
235.34.0075	EC5 accessory kit
235.25.0010	Kit locking collapsible hinge left
235.25.0011	Kit locking collapsible hinge right
	4 cables + 1 DAS roofstick
	8 cables + 2 DAS roofsticks
500.28.0501	RRS - mounting kit
202.28.1255	RRS - box beam

5-Alternatives

Article	Description
192.28.2551	Roofstick 2550mm Multi screwed
198.28.2550	Roofstick aluminium 2550mm Multi
213.28.2550	Moving part Multiliner - welded - 2550 mm
8793	Accessory kit - moving part Multiliner - welded - 2550 mm
200.26.2550	Box section 120*40*2550 galvanised
192.34.2551	Fixed roof to suit steel/polyester plate - 2550 - screwed
192.34.6255	Fixed roof to suit steel/polyester plate - 2550 - pressed
192.34.2552	Fixed roof to suit canopy Highliner 2550 - screwed
192.34.7255	Fixed roof to suit canopy Highliner 2550 - pressed
203.28.2550	Box beam 80*40*2550
218.34.1025	Collapsible backside for Fixed roof

1-TIR Packets

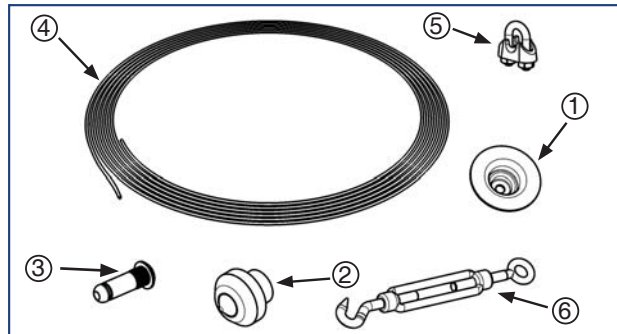

TIR PACKET 235.25.0002

	DESCRIPTION	REFERENCE
1	Shell 40mm TIR	[290.25.0004]
2	Stopper TIR	[290.25.0005]
3	Pin TIR	[290.25.0003]
4	TIR cable -red	[290.25.0009]
5	Cable clip	[8761]
6	Tightening screw M8	[140.25.0043]

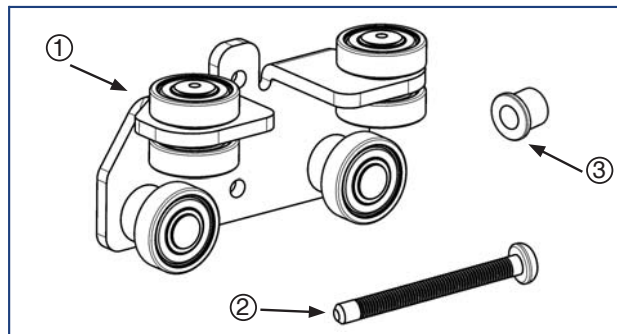

TIR PACKET SIDE CURTAIN ROLLERS

	DESCRIPTION	REFERENCE
1	Side curtain roller TIR	[242.34.0055]
2	Maxlock nail	[151.25.0004]
3	Maxlock ring	[151.25.0005]

