

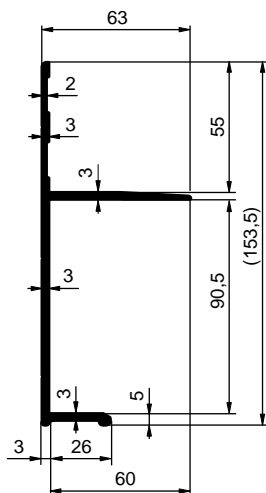

Hliníkové profily skříně / Hliníkové profily skrine / Profile kontenera

HLINÍKOVÉ PROFILY PLATA / HLINÍKOVÉ PROFILY PLATA / PROFILE ALUMINIOWE RAMY



6600012415	al
6612012415	elox/anoda
Profil obvodový skříně 90mm Profil obvodový skrine 90mm Profil obvodowy kont. 90mm	
AlMgSi 0,5	1,828 kg m

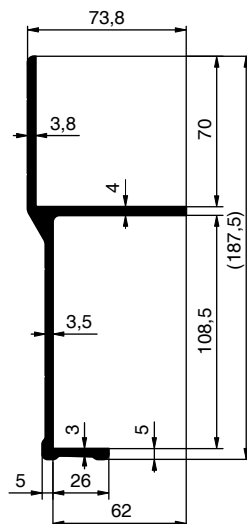

6600007971	al
6612007971	elox/anoda
Profil obvodový skříně 108/- mm Profil obvodový skrine 108/- mm Profil obvodowy kontenera 108/- mm	
AlMgSi 0,5	2,980 kg m

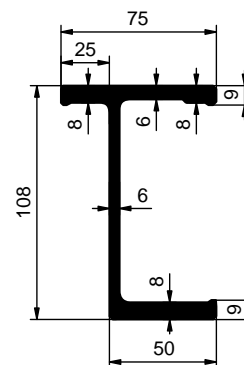

6600011592	al
6612011592	elox/anoda
Profil pomocného rámu T 108 mm Profil pomocného rámu T 108 mm Profil pomocniczy ramy T 108 mm	
AlMgSi 0,5	4,096 kg m

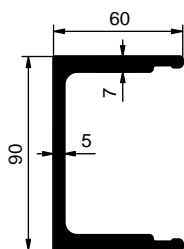

6600007316	al
6612007316	elox/anoda
Profil pomocného rámu 90 mm Profil pomocného rámu 90 mm Profil pomocniczy ramy 90 mm	
AlMgSi 0,7	3,130 kg m

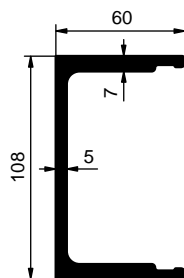

6600007317	al
6612007317	elox/anoda
Profil pomocného rámu 108 mm Profil pomocného rámu 108 mm Profil pomocniczy ramy 108 mm	
AlMgSi 0,7	3,370 kg m

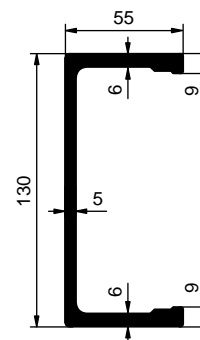

6600012075	al
6612012075	elox/anoda
Profil pomocného rámu T 108 mm Profil pomocného rámu T 108 mm Profil pomocniczy ramy T 108 mm	
AlMgSi 0,5	4,096 kg m

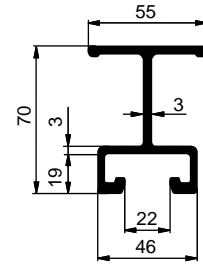
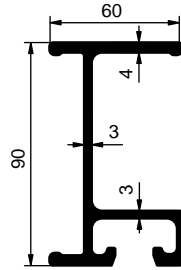
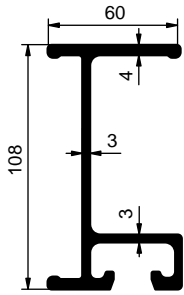

6600007315	al
6612007315	elox/anoda
Profil příčný 108 mm	
Profil priečný 108 mm	
Profil poprzeczny 108 mm	
AlMgSi 0,7	2,500 kg m

6600007319	al
6612007319	elox/anoda
Profil příčný 90 mm	
Profil priečný 90 mm	
Profil poprzeczny 90 mm	
AlMgSi 0,7	2,290 kg m

660012073	al
6612012073	elox / anoda
Profil příčný 70mm	
Profil priečný 70mm	
Profil poprzeczny 70mm	
AlMgSi 0,7	1,769 kg m

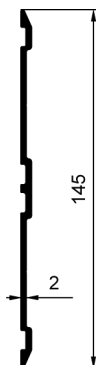
**HLINÍKOVÉ PROFILY SKŘÍNE / HLINÍKOVÉ PROFILY SKRINE / ALUMINIOWE PROFILE KONTENERA**

6600012382	al
6612012382	elox/anoda
Profil okopový I 145 Profil okopový I 145 Profil ochranný I 145mm	
AlMgSi 0,5	0,867 kg m

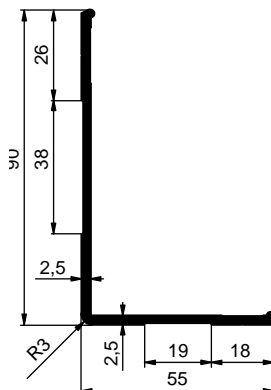

6600011796	al
6612011796	elox/anoda
Profil L 90x55mm Profil L 90x55mm Profil L 90x55mm	
AlMgSi 0,5	0,900 kg m

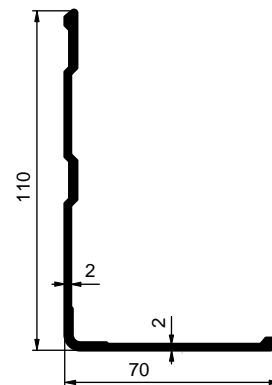

6600008087	al
6612008087	elox/anoda
Profil vnější L 110x70 mm Profil vonkajší L 110x70 mm Profil zewnętrzny L 110x70 mm	
al	1,09 kg m

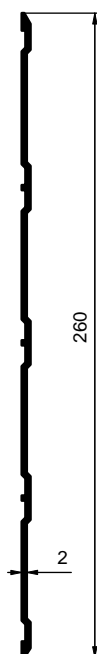

6600007460	al
6612007460	elox/anoda
Profil okopový I 260 mm Profil okopový I 260 mm Profil ochranný I 260 mm	
AlMgSi 0,5	1,570 kg m

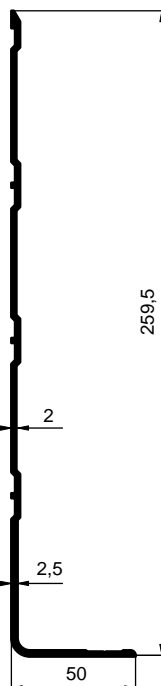

6600007461	al
6612007461	elox/anoda
Profil okopový L 260x50 mm Profil okopový L 260x50 mm Profil ochranný L 260x50 mm	
AlMgSi 0,5	1,970 kg m

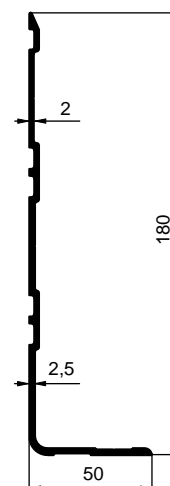

6600012383	al
6612012383	elox/anoda
Profil okopový L 180x50 Profil okopový L 180x50 Profil ochranný L 180x50	
AlMgSi 0,5	1,428 kg m



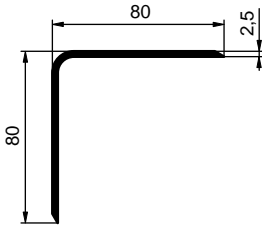

6600007753	al	
6612007753	elox/anoda	
Profil vnější L 80×80 mm Profil vonkajší L 80×80 mm Profil zewnętrzny L 80×80 mm		
AlMgSi 0,5	1,050 kg	m

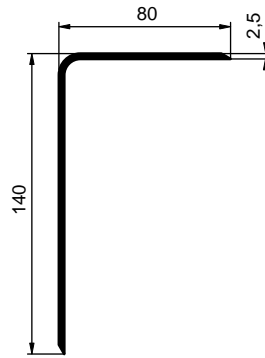

6601029063	al	
6612029063	elox/anoda	
Profil L 140×80 mm Profil L 140×80 mm Profil L 140×80 mm		
AlMgSi 0,5	1,43 kg	m

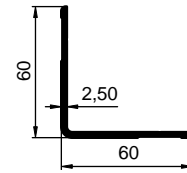

6600007767	al	
6612007767	elox/anoda	
Profil vnitřní L 60×60 mm Profil wnątorny L 60×60 mm Profil wewnętrzny L 60×60 mm		
AlMgSi 0,5	0,730 kg	m

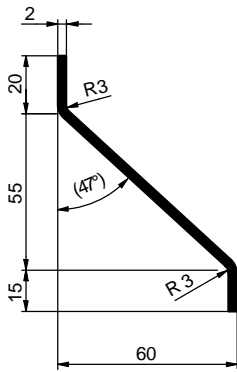

62800PLY00	RAL 9007	
Okapnice klapky Z, 2500mm Okapnica klapky Z, 2500mm Okapnik klapki Z, 2500mm		
al	1,050 kg	m

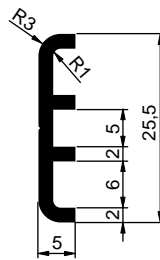

4153600100	al	
Profil Al plochy 25,5x5 mm Profil Al plochy 25,5x5 mm Profil Al plochy 25,5x5 mm		
al	0,200 kg	m

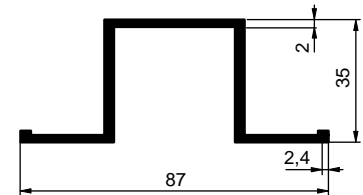

6600008043	al	
Profil střechy omega 35 mm Profil strechy omega 35 mm Profil dachowy omega 35 mm		
al	0,910 kg	m

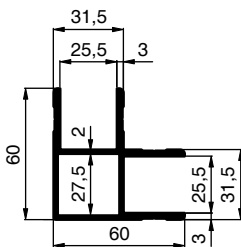

6600007870	al	
6612007870	elox/anoda	
Profil L 25×60×60 mm Profil L 25×60×60 mm Profil L 25×60×60 mm		
AlMgSi 0,5	1,485 kg	m

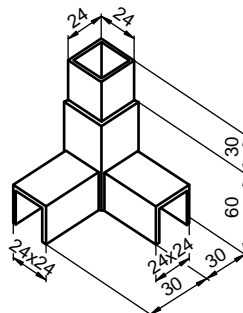

1000008356	al	
Roh hliníkový Roh hliníkový Narože górne kontenera		
AlMgSi 0,5	0,130 kg	m

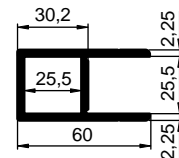

1001014206	al	
Profil lemovací 25 mm Profil lemovací 25 mm Profil zakończeniowy 25 mm		
AlMgSi 0,5	0,900 kg	m

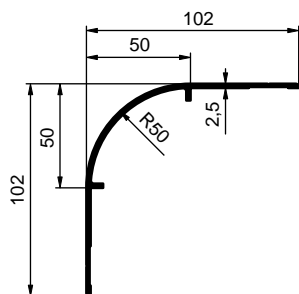

1000006817	al
Profil rohový R50 vnější	
Profil rohový R50 vonkajší	
Profil narožny R50 zewnętrzny	
AlMgSi 0,5	1,250 kg m

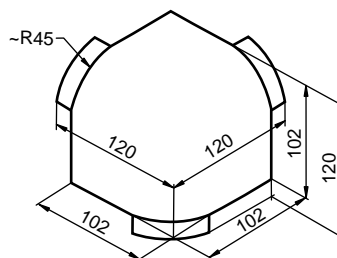

1000003654	al
Kryt rohu skříně	
Kryt rohu skrine, al. odliatok	
Narože górne kontenera	
AlMgSi 0,5	0,280 kg ks/szt

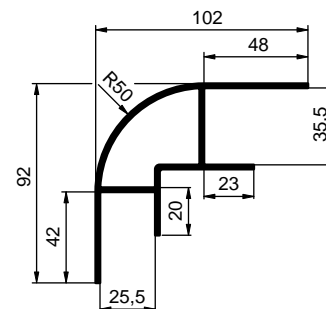

1000020517	al
Profil rohový R50, 25×35 mm	
Profil rohový R50, 25×35 mm	
Profil narožny R50, 25×35 mm	
AlMgSi 0,5	2,210 kg m

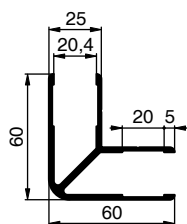

1000009287	al
1000092871	elox/anoda
Profil rohový 20 mm, 60×60 mm	
Profil rohový 20 mm, 60×60 mm	
Profil narožny 20 mm, 60×60 mm	
AlMgSi 0,5	1,170 kg m

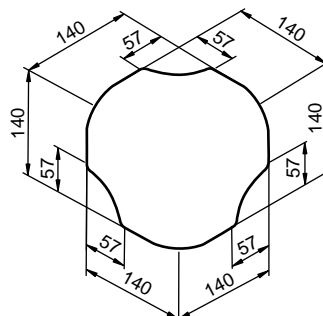

2614055099	RAL 9007
2600055099	al
Roh skříně	
Roh skrine	
Narože górne kontenera pod PLY	
AlMgSi 0,5	0,250 kg ks/szt

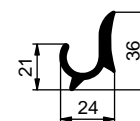

6600003176	al
6612003176	elox/anoda
Profil okapový	
Profil odkvapový	
Profil okapowy	
AlMgSi 0,5	1,43 kg m

HLINÍKOVÉ PROFILY DVEŘÍ / HLINÍKOVÉ PROFILY DVERÍ / ALUMINIOWE PROFILE DRZWI

HLINÍKOVÉ PROFILY SKŘÍNĚ

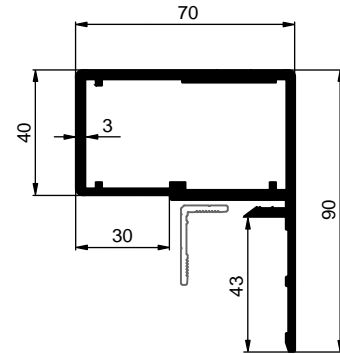
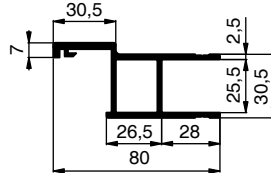
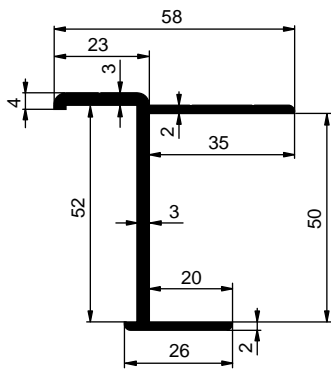

6612011797	elox/anoda
Profil dveří	
Profil dverí	
Profil drzwi	
AlMgSi 0,5	0,932 kg m

660008066	al
6612008066	elox/anoda
Profil dveří lemovací 25 mm	
Profil dverí lemovací 25 mm	
Profil zakończeniowy drzwi 25 mm	
AlMgSi 0,5	1,420 kg m

66L0012234	al
66L2012234	elox/anoda
Profil portálu skříně ARCAL	
Profil AL rámu ARCAL	
Profil portalu kontenera ARCAL	
AlMgSi 0,5	2,195 kg m

HLINÍKOVÉ PROFILY SKRINE

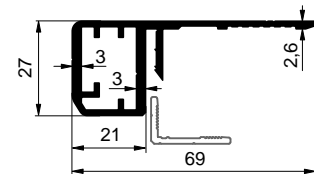
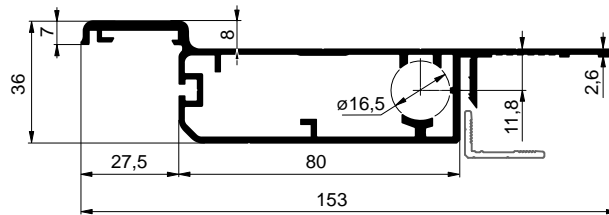
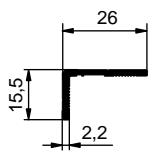

66L2011791	elox/anoda
Profil boční-střešní vnitřní	
Profil boční-střešní vnitřní	
Profil bočný-dachowy wewn.	
AlMgSi 0,5	0,211 kg m

66L2012495	elox/anoda
Profil křídla dveří	
Profil křídla dverí	
Profil skrzydła drzwi	
AlMgSi 0,5	2,000 kg m

66L2012496	elox/anoda
Profil rámu dveří	
Profil rámu dverí	
Profil ramy drzwi	
AlMgSi 0,5	1,010 kg m



1001009681:

Těsnění gumové pro profil dveří, hladké / Tesnenie gumové pre profil dverí, hladké / Uszczelka profilu drzwi gładka

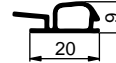

1001009681

PROFILE KONTENERA



2011/07/13

SKŘÍŇOVÉ NÁSTAVBY
SKRIŇOVÉ NADSTAVBY
ZABUDOWY KONTENEROWE



HLINÍKOVÉ PROFILY PLYWOOD / HLINÍKOVÉ PROFILY PLYWOOD / ALUMINIOWE PROFILE PLYWOOD

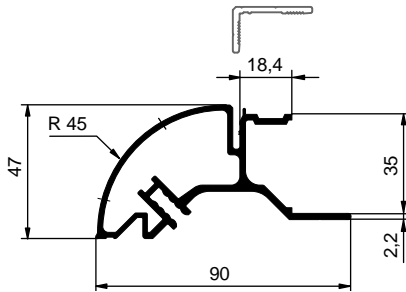

66L2011794	elox/anoda	
Profil střešní Profil strešný Profil dachowy	AlMgSi 0,5	1,604 kg m

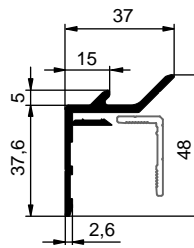

66L2011790	elox/anoda	
Profil boční-střešní vnější Profil bočný-střešný vonkajší Profil boczny-dachowy zewn.	AlMgSi 0,5	0,590 kg m

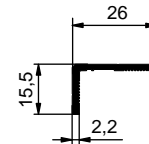

66L2011791	elox/anoda	
Profil boční-střešní vnitřní Profil bočný-střešný vnútorný Profil boczny-dachowy wewn.	AlMgSi 0,5	0,211 kg m

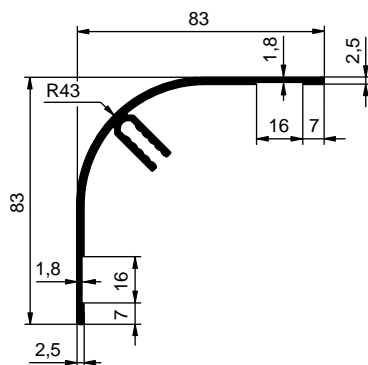

66L2011792	elox/anoda	
Profil svislý vnější Profil bočný-střešný vonkajší Profil pionowy zewn.	AlMgSi 0,5	1,179 kg m

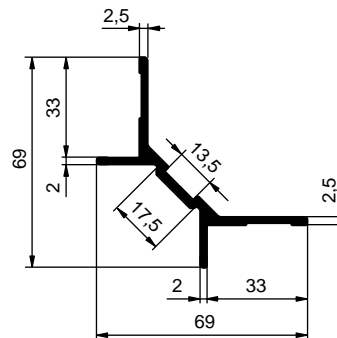

66L0011793	al	
Profil svislý vnitřní Profil zvislý vnútorný Profil pionowy wewn.	AlMgSi 0,5	0,808 kg m

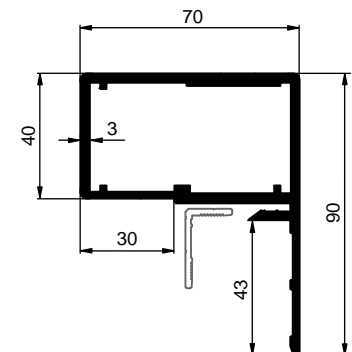

66L0012234	al	
66L2012234	elox/anoda	
Profil portálu skříně ARCAL Profil AL rámu ARCAL Profil portalu kontenera ARCAL	AlMgSi 0,5	2,195 kg m



Související díly / Súvisiace diely / Elementy dodatkowe :

6200005516: Šroub 5,5x16 DIN 7981 / Skrutka 5,5x16 DIN 7981 / Śruba 5,5x16 DIN 7981

6200005519: Šroub 5,5x19 DIN 7981 / Skrutka 5,5x19 DIN 7981 / Śruba 5,5x19 DIN 7981

6200005525: Šroub 5,5x25 DIN 7981 / Skrutka 5,5x25 DIN 7981 / Śruba 5,5x25 DIN 7981

6200005532: Šroub 5,5x32 DIN 7981 / Skrutka 5,5x32 DIN 7981 / Śruba 5,5x32 DIN 7981

6200006319: Šroub 5,5x19 DIN 7981 / Skrutka 5,5x19 DIN 7981 / Śruba 5,5x19 DIN 7981

6200006325: Šroub 5,5x25 DIN 7981 / Skrutka 5,5x25 DIN 7981 / Śruba 5,5x25 DIN 7981

6200006332: Šroub 5,5x32 DIN 7981 / Skrutka 5,5x32 DIN 7981 / Śruba 5,5x32 DIN 7981

6200000516: Vrut 5x16 DIN 7505 / Skrutka 5x16 DIN 7505 / Śruba 5x16 DIN 7505

HLINÍKOVÉ PROFILY SKŘÍNĚ

HLINÍKOVÉ PROFILY SKRINE

PROFILE KONTENERA



ALU-S.V.
www.alu-sv.com

ČESKO: Průmyslová 2, 102 00 Praha 10 - Hostivař, Tel.: +420 266 090 511
SLOVENSKO: Kamenná 19, 010 01 Žilina, Tel.: +421 41 707 39 11
POLSKA: ul. Wrocławska 33d, Długoleśka, 55-095 Mirków, Tel.: +48 71 330 53 11

4.7.G.



HLINÍKOVÉ PROFILY SKŘÍNĚ

HLINÍKOVÉ PROFILY SKRINE

PROFILE KONTENERA

