



DE \_\_\_\_\_

## KIPPERAUFBAUTEN

2.1 Al Bordwände, Bordwandprofile  
30/40/60/65mm

EN \_\_\_\_\_

## TIPPER BODY SYSTEMS

2.1 Aluminium Dropsides, Dropside profiles  
30/40/60/65mm

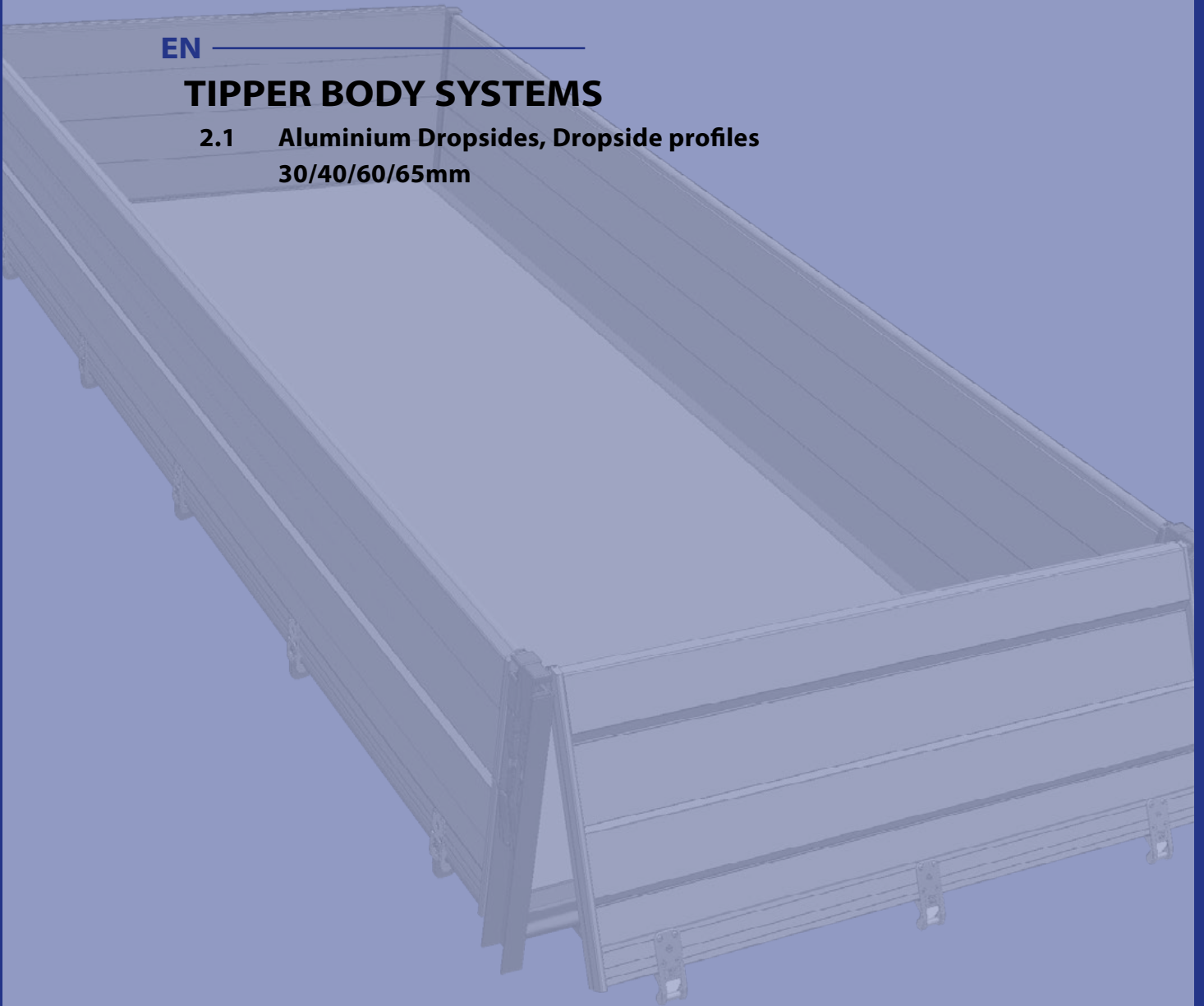





2024/05/23



# Al Bordwände, Bordwandprofile 30/40/60/65mm / Aluminium Dropsides, Dropside profiles 30/40/60/65mm

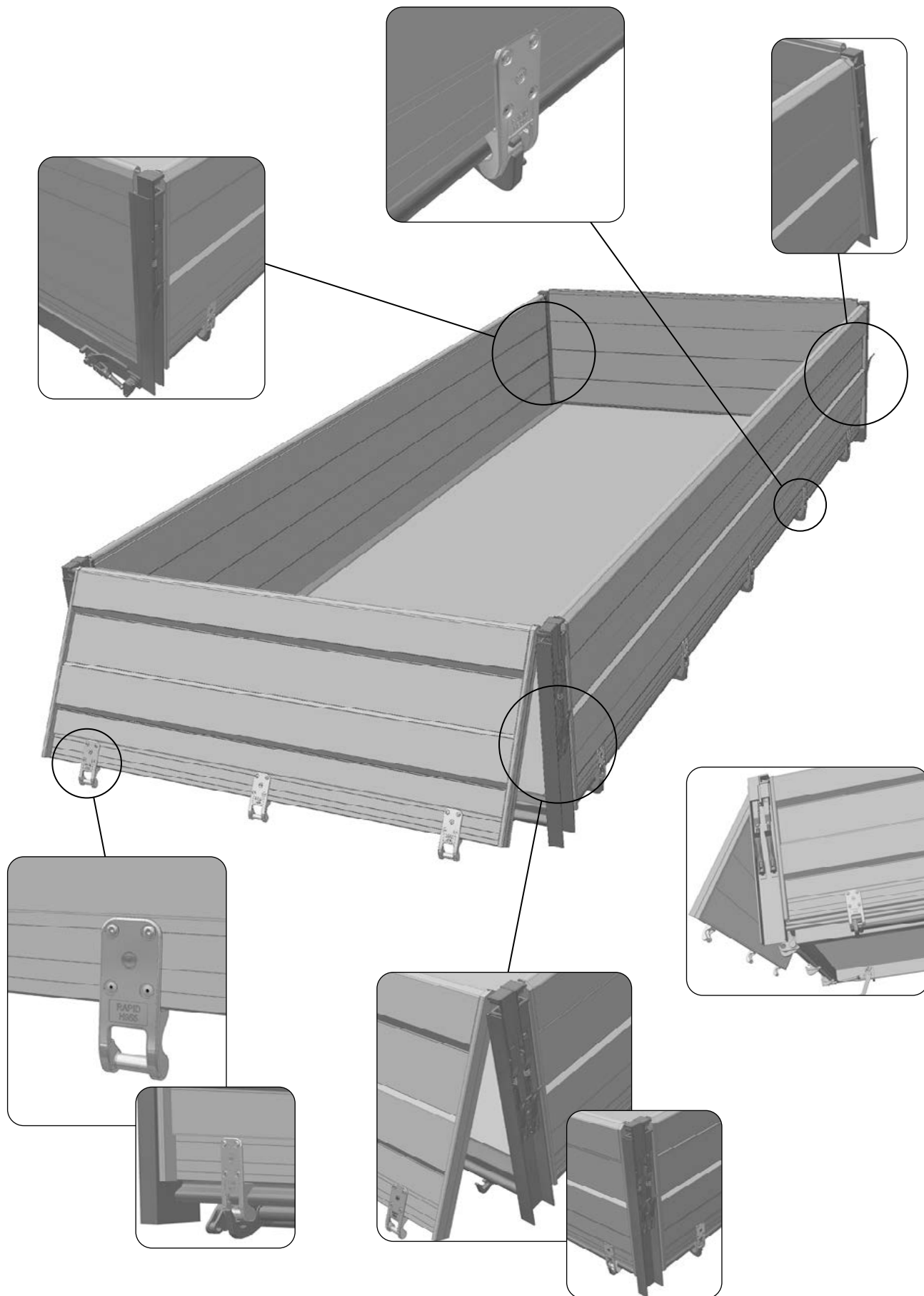

AL BORDWÄNDE, BORDWANDPROFILE 30/40/60/65mm

ALUMINIUM DROPSIDES, DROPSIDE PROFILES 30/40/60/65mm





**DE**

Al-Bordwandprofile ermöglichen eine beliebige Zusammensetzung der Bordwände nach Bedarf. Verstärkte Innenwand der Profile sichert lange Lebensdauer. Nach Zusammenstellung der Profile sind diese nicht mehr voneinander zu trennen. Abschlussprofile werden an die Bordwand angeschweißt. Höhe der Einzelprofile beträgt 100, 150, 175 und 200mm. Stärke der Bordwand beträgt 30 oder 40mm, einige Profile ermöglichen Stärke 60, 65 oder 70mm.

**Wichtigste Eigenschaften der Al-Bordwände:**

- niedriges Gewicht
- hohe Festigkeit
- Korrosionsbeständigkeit
- einfache Montage
- minimale Wartungsanforderungen
- modernes Design

**EN**

Aluminium profiles are suitable for assembly of Dropsides based on customer request. Internal wall is made thicker for stiffness and longer service life. When the profiles are clicked together, it is not possible to disassemble them. Edges are always welded to the Dropside. The heights of single profiles are 100, 150, 175 or 200mm. The width of Dropsides are 30 or 40mm according to the module and some of them (40mm) can be extended to 60 and 65mm to provide better strength.

**Basic characteristic of aluminium Dropsides:**

- low weight,
- high firmness,
- corrosion resistant,
- easy assembly,
- minimum service needed,
- modern design.

**KIPPER 30mm / TIPPER 30mm**

**DE**

Al-Bordwände 30mm ermöglichen Innenbreite bis zu 2480mm. Bordwände werden in Teilen oder als Satz inklusive Rungen, Scharniere und Verschlüsse geliefert. Bordwandhöhe ist von Anforderungen transportierter Ware abhängig und kann auch aus Aufsatzwänden zusammengestellt werden. Bordwände werden um das untere Scharnier aufgemacht oder nach Entsicherung um das obere Scharnier. Am häufigsten werden die Kippaufbauten in Wirtschaft oder Bauwesen eingesetzt, für Transport von Schüttgütern oder in Kombination mit hydraulischem Kran.

**EN**

Aluminium Dropside allows to have internal width of the structure 2480mm. Dropsides can be supplied as parts or as complete set even with pillars, hinges and locks. Dropside height is adjusted depending on the requirements of the cargo with a possibility of 2 part execution/design/version. Dropside can be opened using top or bottom hinges. Hinges let to open top or bottom part of Dropsides. Mostly used for agriculture, building industries, substrates transport or a combination with crane.



**OBERE KIPPERPROFILE 30mm / DROPSIDE TOP PROFILES 30mm**

1120029526	Al
Oberes Kipperprofil 100×30mm Tipper top profile 100×30mm	
Al	3,250 kg m

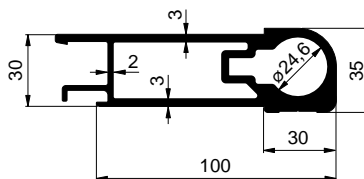
**MITTLERE KIPPERPROFILE 30mm / DROPSIDE MIDDLE PROFILES 30mm**

1120029605	Al
Mittleres Kipperprofil 100×30mm Tipper middle profile 100×30mm	
Al	1,860 kg m

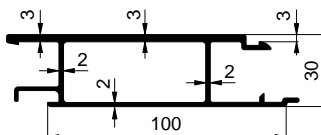

1120029614	Al
Mittleres Kipperprofil 150×30mm Tipper middle profile 150×30mm	
Al	2,760 kg m

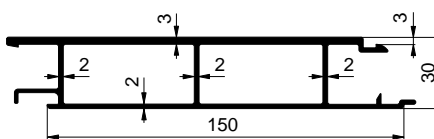

1120029604	Al
Mittleres Kipperprofil 200×30mm Tipper middle profile 200×30mm	
Al	3,420 kg m

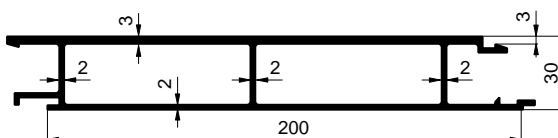
**UNTERE KIPPERPROFILE 30mm / DROPSIDE BOTTOM PROFILES 30mm**

1120029620	Al
Unteres Kipperprofil 100×30mm mit Fahne Tipper bottom profile 100×30mm	
Al	2,024 kg m

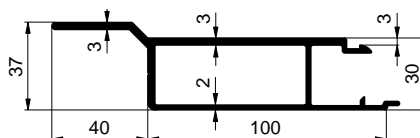

1120029111	Al
Unteres Kipperprofil 175×30mm Tipper bottom profile 175×30mm	
Al	3,618 kg m

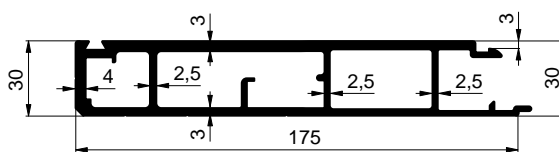
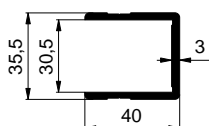
**EINFASSPROFILE FÜR BORDWÄNDE 30mm / EDGING DROPSIDE PROFILES 30mm**

6600006915	Al
Einfassprofil U 30mm Tipper edging profile U 30mm	
Al	0,743 kg m

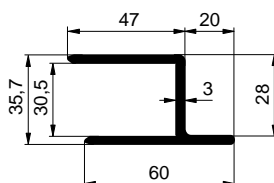

2200611015	Al
Einfassprofil h 30mm Tipper edging profile h 30mm	
Al	1,095 kg m

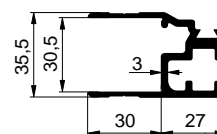

1120007518	Al
Einfassprofil K20/30mm Tipper edging profile K20/30mm	
Al	1,331 kg m



## KIPPERAUFBAU 40/60/65mm / TIPPER 40/60/65mm

### UNTERE KIPPERPROFILE 40mm / DROPSIDE PROFILE 40mm BOTTOM

<b>66S5200400</b>		
Unteres Kipperprofil 200x40mm Tipper profile bottom 200x40mm		
AlMgSi 0,5	4,680 kg	m

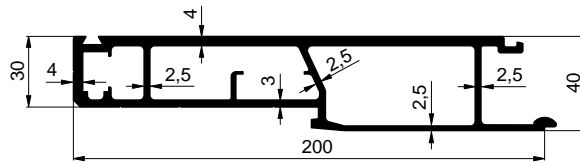

<b>1142004649</b>		
Unteres Kipperprofil 200x40mm, mit Fahne Tipper profile bottom 200x40mm, flange		
AlMgSi 0,5	4,670 kg	m

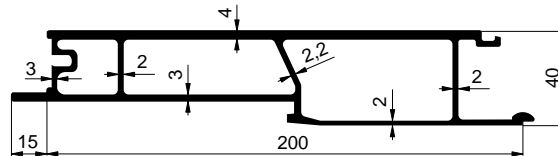

### MITTLERE KIPPERPROFILE 40/60mm / DROPSIDE PROFILE 40/60mm MIDDLE

<b>66S3200400</b>		
Mittleres Kipperprofil 200x40mm Tipper profile middle 200x40mm		
AlMgSi 0,5	3,596 kg	m

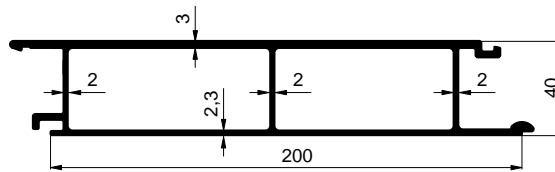

<b>1142037273</b>		
Mittleres Kipperprofil 100x40mm Tipper profile middle 100x40mm		
AlMgSi 0,5	2,270 kg	m

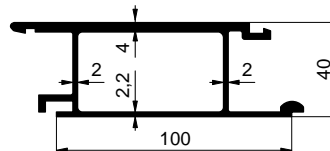

<b>66S3200600</b>		
Mittleres Kipperprofil 200x60mm Tipper profile middle 200x60mm		
AlMgSi 0,5	4,840 kg	m

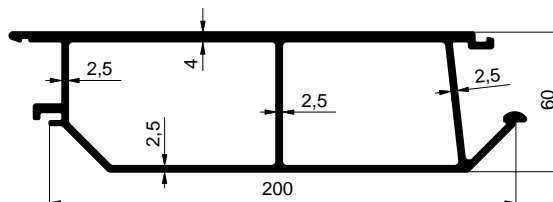

Zubehör / Related parts:

**2300030591 (Gummi/rubber):** Dichtung K20 schwarz / Seal K 20, black

**1121151408 (Gummi/rubber):** Dichtung für unteres Kipperprofil / Seal for the bottom profile



2300030591



1121151408

**OBERE KIPPERPROFILE 40/65mm / DROPSIDE PROFILE 40/65mm TOP**

<b>1141037243</b>
Oberes Kipperprofil 200x40mm Tipper profile top 200x40mm
AlMgSi 0,5    4,331 kg    m

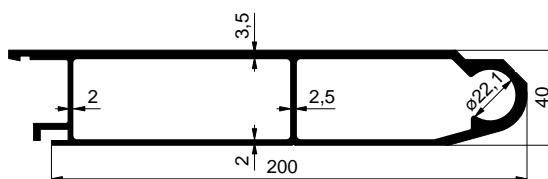

<b>66S1200650</b>
Oberes Kipperprofil 200x65mm Tipper profile top 200x65mm
AlMgSi 0,5    6,320 kg    m

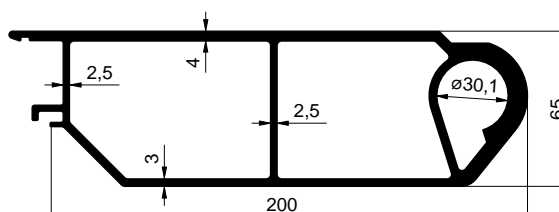
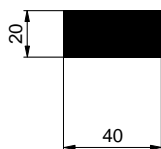
**EINFASSPROFILE FÜR BORDWÄNDE 40/60/65mm  
EDGING DROPSIDE PROFILE 40/60/65mm**

<b>F100100041</b>
Stange 40x20mm Rod 40x20mm
AlMgSi 0,5    2,160 kg    m

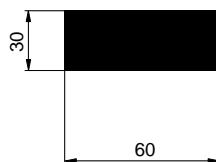

<b>F100100063</b>
Stange 60x30mm Rod 60x30mm
AlMgSi 0,5    4,878 kg    m

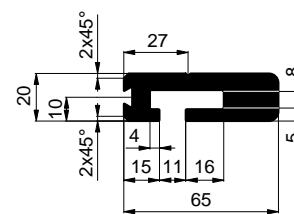

<b>66S7065200</b>
Einfassprofil für Kipper 65x20mm Edging profile for tipper 65x20mm
AlMgSi 0,5    2,590 kg    m

**Technische Information / Technical information:**

Nach Kundenwunsch die Kipperbordwand mit gewünschten Einfassprofil angepasst werden. / For customer request it is possible to put any kind of edge (for tipper Dropside).

<b>1001000762</b>	verzinkt / zn
Bolzen für Kipperbordwand ø30mm H11 Pin for drop-side tipper ø30mm H11	
Stahl/steel    1,400 kg    Stk/pc	

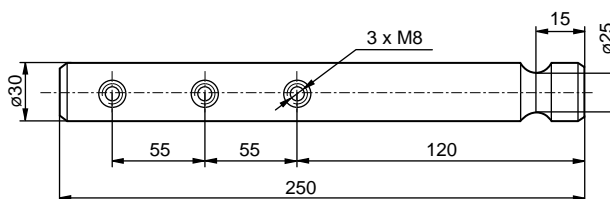

<b>1001000761</b>	verzinkt / zn
Bolzen für Kipperbordwand ø22mm H10 Pin for drop-side tipper ø22mm H10	
Stahl/steel    0,600 kg    Stk/pc	

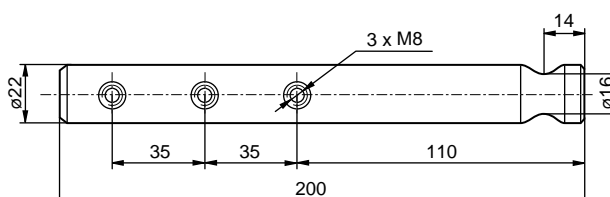

MUSTERAUFBAU / EXAMPLES

AL BORDWÄNDE, BORDWANDPROFILE 30/40/60/65mm



ALUMINIUM DROPSIDES, DROPSIDE PROFILES 30/40/60/65mm







2024/05/23

# KIPPERAUFBAUTEN TIPPER BODY SYSTEMS

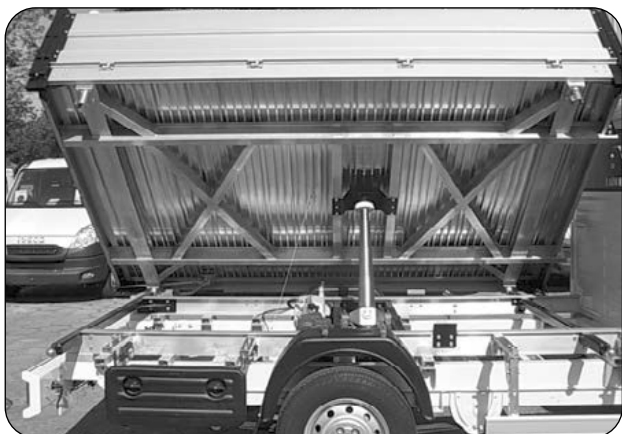

AL BORDWÄNDE, BORDWANDPROFIL 30/40/60/65mm

ALUMINIUM DROPSIDES, DROPSIDE PROFILES 30/40/60/65mm



**ALU-SV CZ**  
[www.alu-sv.com](http://www.alu-sv.com)

**TSCHECHIEN / CZECH REPUBLIC:**  
Průmyslová 1445/2, 102 00 Praha 10, Tel.: +420 266 090 511, E-Mail: [verkauf@alu-sv.com](mailto:verkauf@alu-sv.com), [sales@alu-sv.com](mailto:sales@alu-sv.com)  
Technische Änderungen vorbehalten. / Subject to technical changes.

**2.1.G.**

AL BORDWÄNDE, BORDWANDPROFILE 30/40/60/65mm

ALUMINIUM DROPSIDES, DROPSIDE PROFILES 30/40/60/65mm

