



**PL**

- Grupa firm ALU-SV GROUP powstała przez połączenie trzech firm ALU-SV w Pradze (1993), Zilinie (1996) i Wrocławiu (2002).
- ALU-SV GROUP oferuje dostawy towaru w zakresie elementów do nadbudowy samochodów ciężarowych, a także elementy na fasady budynków ALUCOBOND.

• W naszej ofercie znajdziecie szeroki asortyment elementów do tworzenia i konstrukcji zabudów samochodów ciężarowych, przyczep i naczep. W ramach ALU-SV GROUP współpracujemy z ponad 70 dostawcami z całej Europy, jak również pomiędzy poszczególnymi firmami w ramach grupy.

**EN**

- ALU - S.V. GROUP offers services and deliveries related to accessories for cargo truck superstructures.
- Within our product offering, you'll find a wide variety of products for manufacturing and constructing extensions for cargo trucks, trailers, and semi-trailers.
- We will gladly deliver materials to your company's doorstep. Our salespeople are more than happy to visit you and introduce our current product offering. All consultations and technical solutions are provided at the customer's site or at our drafting and design office.

**DE**

- Gesellschaftsgruppe (Konzern) ALU-SV bietet Dienstleistungen und Lieferungen im Bereich von Teilen und Aufbauten für LKW und Anhängerfahrzeuge an.
- Im Angebot befindet sich breite Palette von Teilen- und Produkten für die Herstellung der Aufbauten einsch. Konstruktionsvorschlägen (projekten), komplexe Auftragsabwicklung und Projekten von Neuteilen und ALU-Profilen.. Im Lieferungsbestandteil ist auch finale Oberflächengestaltung.
- Unser Ziel ist, Highteile und Highprodukte mit einer Qualitätsgarantie entsprechender europäischen Techniklage anbieten. Schnelle und zuverlässige Lieferungen zu den Kunden sind natürlich. (selbstverständlich).

Właściwości wytrzymałościowe stosowanych stopów aluminium: / Strength properties of aluminum alloys used: / Festigkeitseigenschaften der Aluminiumlegierungen:

Gęstość / Density / Dichte 2,7 kg/dm<sup>3</sup>

Moduł sprężystości / Modulus / Modul 70 000 N/mm<sup>2</sup>

Dotychczasowe oznaczenie Earlier signs Frühere Schilder	Nowa norma The new standard Der neue Standard	Granica plastyczności Yield strength Streckgrenze ReH [MPa]	Wytrzymałość na rozciąganie Tensile strength Zugfestigkeit Rm [MPa]
AlMgSi0,5	EN AW 6060 T66	160	215
AlMgSi0,7	EN AW 6005A T6	225	270
AlMgSi1	EN AW 6082 T6	250	290





2020/09/30



## PROFILE ALUMINIOWE RAMY / ALUMINUM FRAME / HILFSRAHMEN FÜR PRITSCHEN

### PROFILE POPRZECZNE / CROSSBARS / QUERTRÄGER

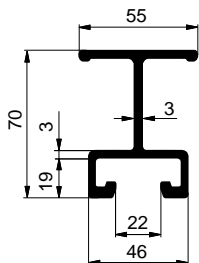

6600012073 - Al  
6612012073 - elox/anoda

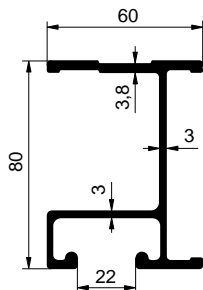

6600007339 - Al

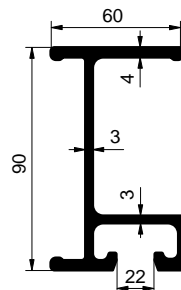

6600007319 - Al  
6612007319 - elox/anoda

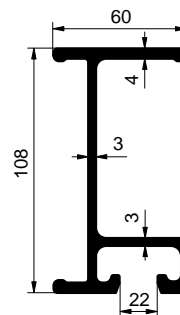

6600007315 - Al  
6612007315 - elox/anoda

### PROFILE POMOCNICZE RAMY / SUBFRAME / LÄNGSTRÄGER

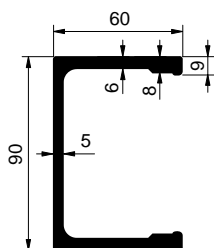

6600007326 - Al  
6612007326 - elox/anoda

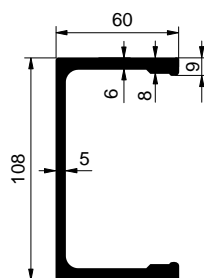

6600007327 - Al  
6612007327 - elox/anoda

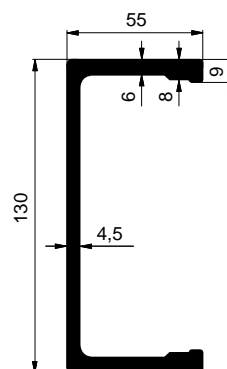

6600012075 - Al  
6612012075 - elox/anoda

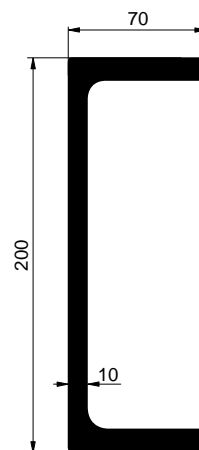

2200641106 - Al

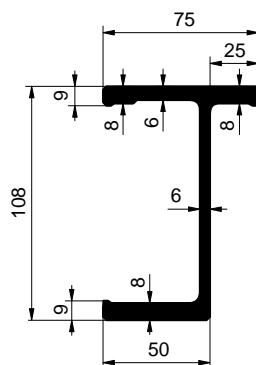

6600011592 - Al  
6612011592 - elox/anoda

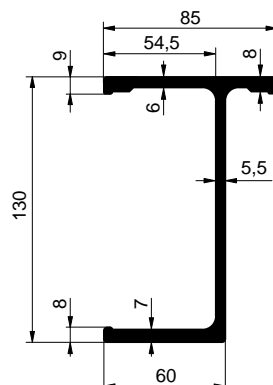

6600111484 - Al  
6612111484 - elox/anoda

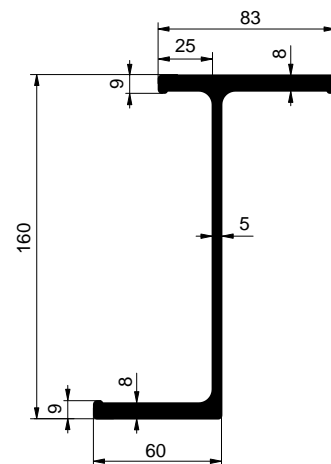

6601101220 - Al  
1121052362 - elox/anoda

PROFILE OBWODOWE / SIDING PROFILES / AUSSENRAHMENPROFILE

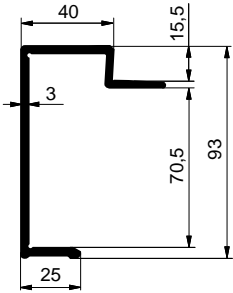

6612012074 - elox/anoda

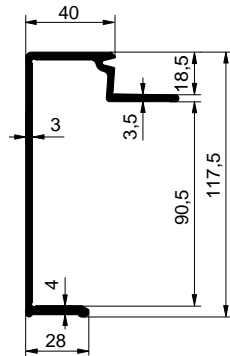

6600007318 - Al  
6612007318 - elox/anoda

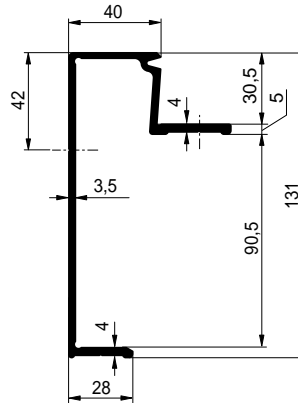

6600014024 - Al  
6612014024 - elox/anoda

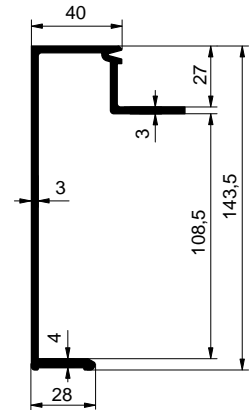

6612007314 - elox/anoda

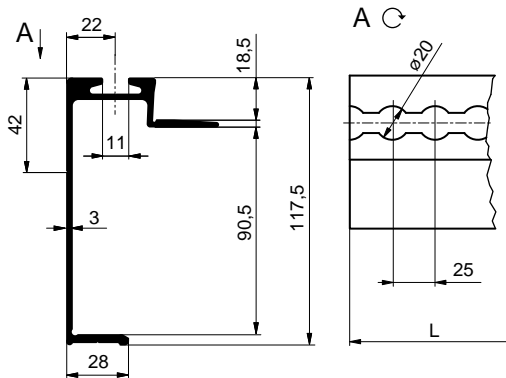

66F2110956 - elox/anoda

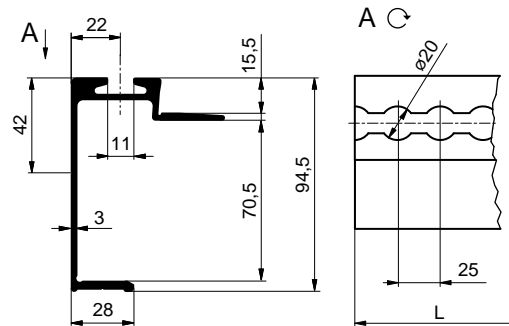

66F2013493 - elox/anoda

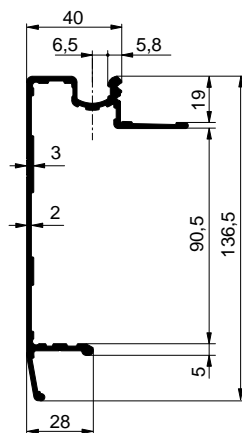

6600013093 - Al  
6612013093 - elox/anoda

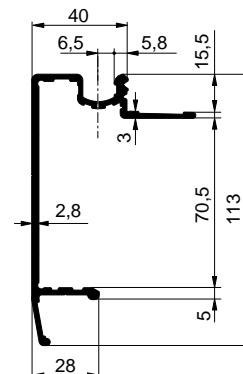

6612013620 - elox/anoda



2020/09/30



# PROFILE BURTOWE / DROPSIDE / BORDWANDPROFILE

## DOLNE / BOTTOM / UNTERE

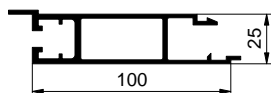

6611008197 - AI  
6611128197 - elox/anoda

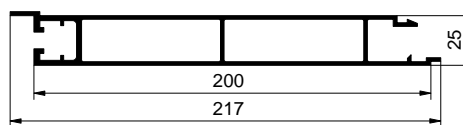

6611007783 - AI  
6611127783 - elox/anoda

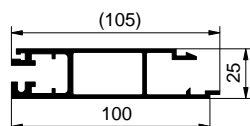

6611007948 - AI  
6611127948 - elox/anoda

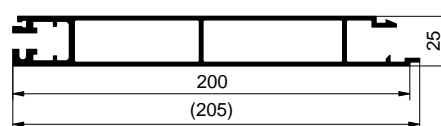
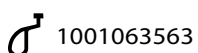

6611007784 - AI  
6611127784 - elox/anoda

## RODKOWE / MIDDLE / MITTLERE

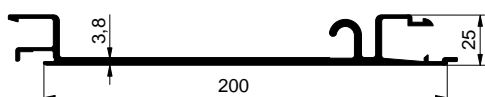

2262128000 - AI

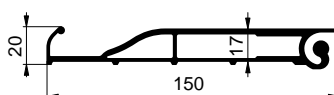

2262128100 - AI

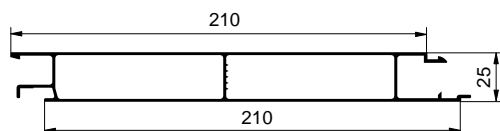

6611001783 - AI  
6611121783 - elox/anoda

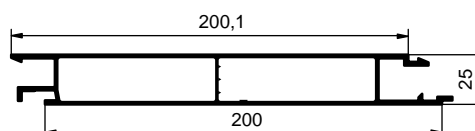

6611001777 - AI  
6611121777 - elox/anoda

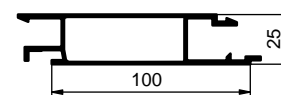

6611007785 - AI  
6611127785 - elox/anoda

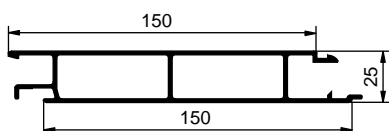

6611012676 - AI  
6611212676 - elox/anoda



6611007045 - AI  
6611127045 - elox/anoda

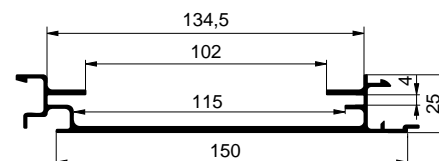

6600013071 - AI  
6612013071 - elox/anoda

## GÓRNE / TOP / OBERE

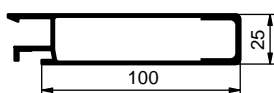

6611008240 - AI

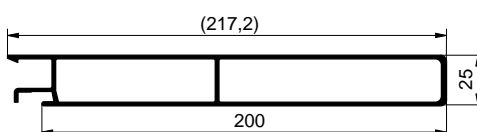

6611008196 - AI  
6611128196 - elox/anoda

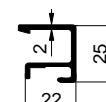

6611744750 - AI

**PROFIL BOCZNY DO CS 25mm / DROPSIDE FOR CS 25mm /  
BORDWAND FÜR CS 25mm**

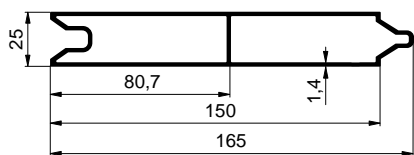

**6600012230 - AI**

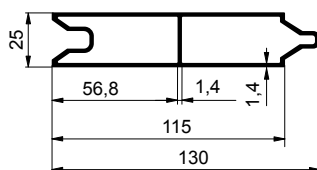

**6600011772 - AI**

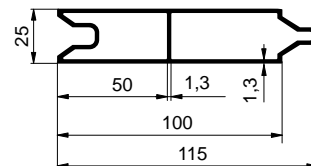

**6600013069 - AI**

**PROFILE BURTOWE / DROPSIDE FOR ALUMINIUM BODY/ BORDWANDPROFILE FÜR PRITSCH**

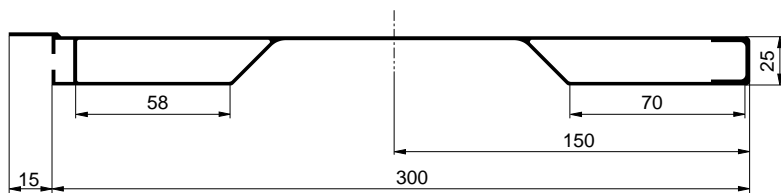

**3ZP0E68300 - elox/anoda**

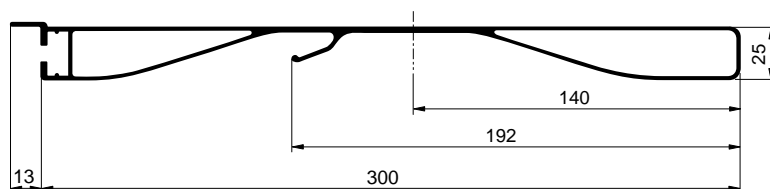

**3BH0300313 - elox/anoda**

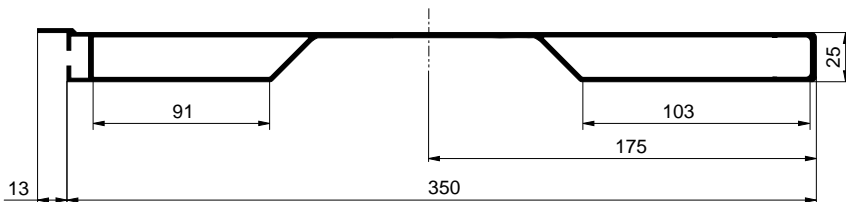

**3ZP0E68350 - elox/anoda**

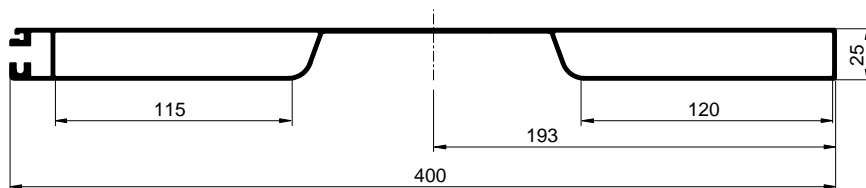

**3ZPTA14818 - AI  
3ZPTE14818 - elox/anoda**

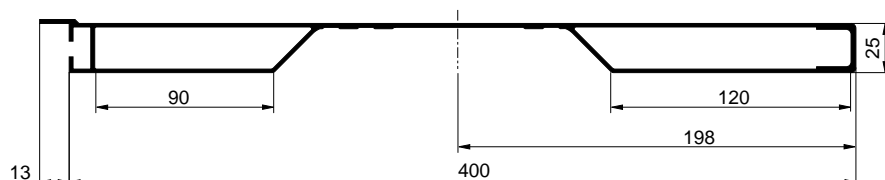
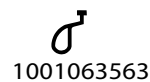

**3BP2025549 - elox/anoda**

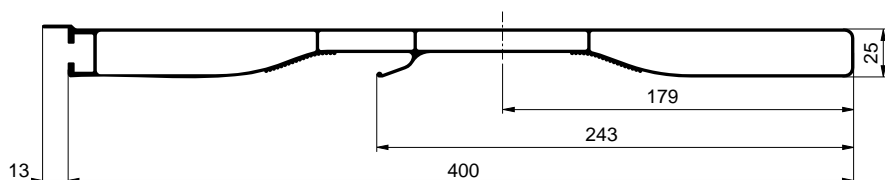

**3BH0400413 - elox/anoda**



2020/09/30



## ZAWIASY LISTWOWE / CONTINUOUS HINGE / STANGENSCHARNIER

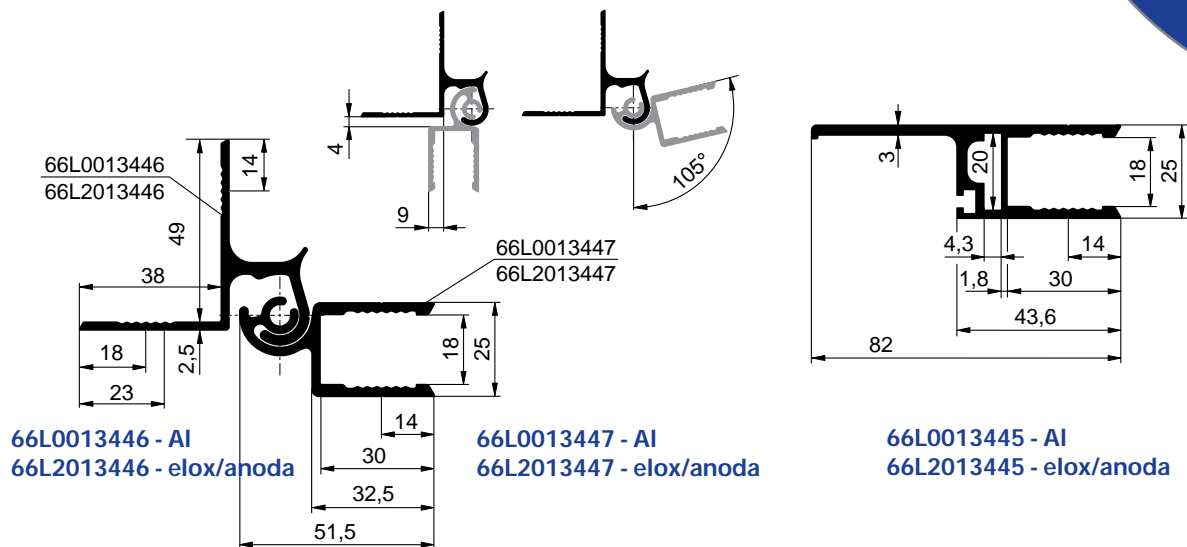

66L0013446 - AI  
66L2013446 - elox/anoda

66L0013447 - AI  
66L2013447 - elox/anoda

66L0013445 - AI  
66L2013445 - elox/anoda

## PROFILE ZAKO CZENIOWE DO BURT / EDGING / EINFASSPROFILE



2300030590



2300030591

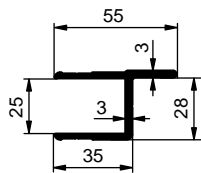

6600012242 - AI  
6612012242 - elox/anoda

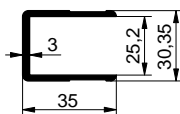

6600012241 - AI  
6612012241 - elox/anoda

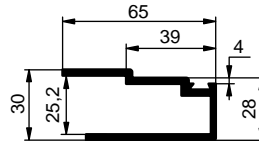

6612008391 - elox/anoda

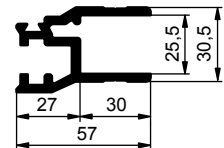

6600007270 - AI  
6612007270 - elox/anoda

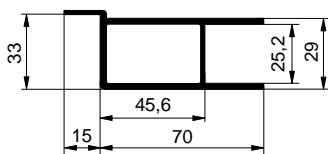

6612012695 - elox/anoda

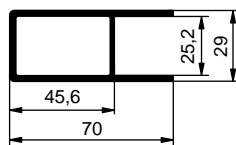

6612012528 - elox/anoda

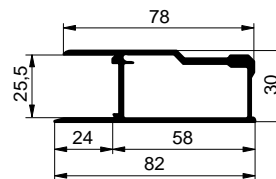

6612010146 - elox/anoda

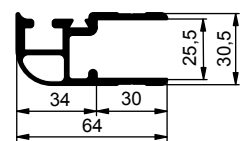

6600007271 - AI  
6612007271 - elox/anoda

## DRZWICZKI TYLNE DZIELONE / SMALL REAR DOORS / HINTERE BORDWANDTÜREN

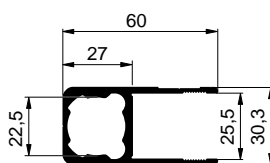

2200621267 - AI  
2212621267 - elox/anoda

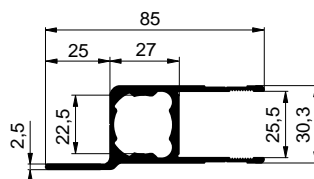

2200621268 - AI  
2212621268 - elox/anoda

**PROFILE WYWROTKOWE / TIPPER BODY / KIPPERAUFBAUTEN**

**PROFILE BURTOWE 30mm GÓRNE / SIDEBOARD TOP PROFILES 30mm /  
OBERE BORDWANDPROFILE 30mm**

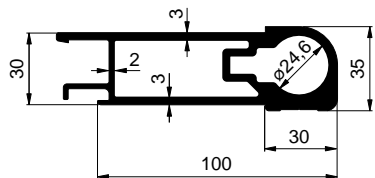

1120029526 - AI

**PROFILE BURTOWE 30mm RODKOWE / SIDEBOARD MIDDLE PROFILES 30mm /  
MITTLERE BORDWANDPROFILE 30mm**

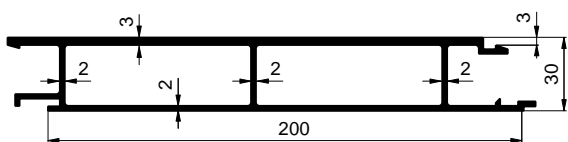

1120029604 - AI

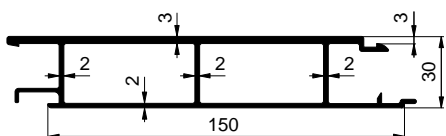

1120029614 - AI

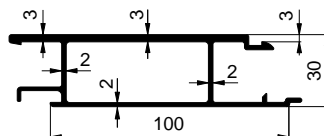

1120029605 - AI

**PROFILE BURTOWE 30mm DOLNE / SIDEBOARD BOTTOM PROFILES 30mm /  
UNTERE BORDWANDPROFILE 30mm**

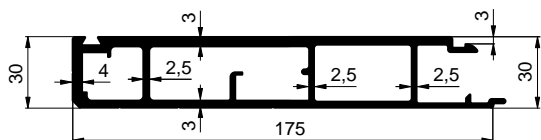

1120029111 - AI

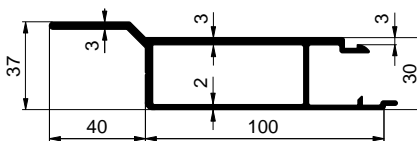

1120029620 - AI

**PROFILE ZAKO CZENIOWE DO BURT 30mm / EDGING SIDEBOARD PROFILES 30mm /  
EINFASSPROFILE 30mm**

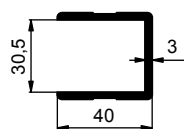

6600006915 - AI

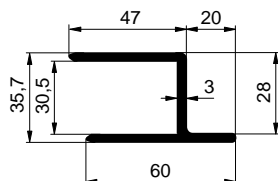

2200611015 - AI

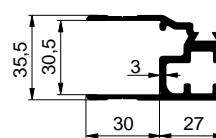

1120007518 - AI





2020/09/30



**PROFILE BURTOWE 40, 65mm GÓRNE / SIDEBOARD TOP PROFILES 40, 65mm /  
OBERE BORDWANDPROFILE 40, 65mm**

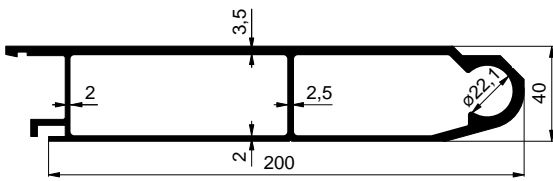

1141037243 - AI

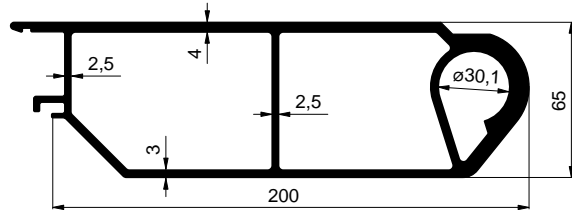

66S1200650 - AI

**PROFILE BURTOWE 40, 60mm RODKOWE / SIDEBOARD MIDDLE PROFILES 40, 60mm /  
MITTLERE BORDWANDPROFILE 40, 60mm**

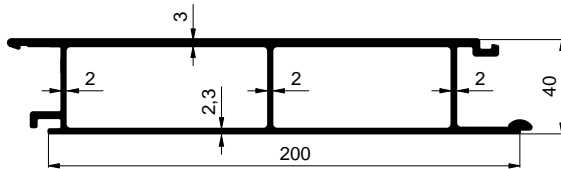

66S3200400 - AI

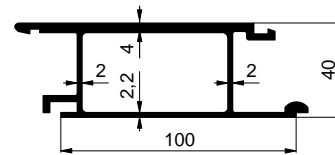

1142037273 - AI

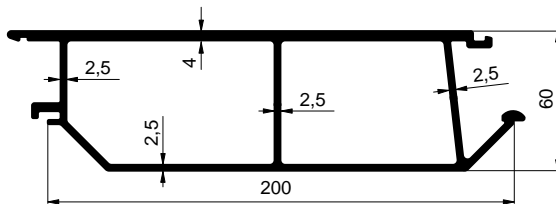

66S3200600 - AI

**PROFILE BURTOWE 40mm DOLNE / SIDEBOARD BOTTOM PROFILES 40mm /  
UNTERE BORDWANDPROFILE 40mm**

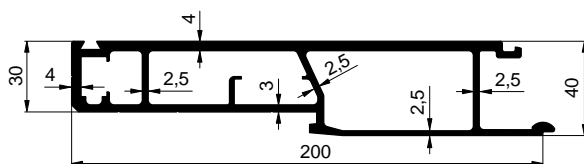

66S5200400 - AI

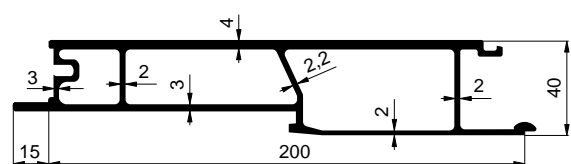

1142004649 - AI



2300030591



1121151408

**PROFILE ZAKO CZENIOWE DO BURT 40/60/65mm / EDGING SIDEBOARD PROFILES 40/60/65mm /  
EINFASSPROFILE 40/60/65mm**

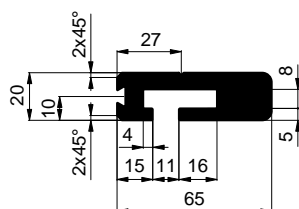

66S7065200 - AI

# PROFILE DO KONSTRUKCJI PLANDEKOWYCH / PROFILES FOR TARPAULIN CONSTRUCTION / PROFILE FÜR PLANENKONSTRUKTIONEN

## PROFILE PROWADZ CE SESAM / GUIDING PROFILE SESAM / DACHPROFILE SESAM

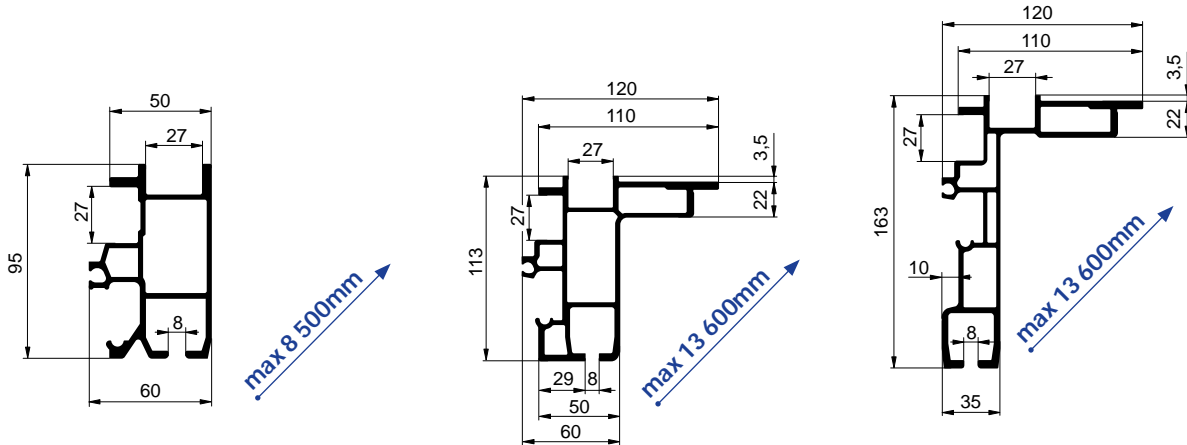

275S004500 - AI (4 500mm)  
 275SN07500 - AI (7 500mm)  
 275S008500 - AI (8 500mm)

275M107800 - AI (7 800mm)  
 275M108500 - AI (8 500mm)  
 275M109500 - AI (9 500mm)  
 275M113600 - AI (13 600mm)

275L107800 - AI (7 800mm)  
 275L108500 - AI (8 500mm)  
 275L109500 - AI (9 500mm)  
 275L113600 - AI (13 600mm)



*Informacja techniczna / Technical information / Technische Informationen:  
 Profile prowadzące są przeznaczone do konstrukcji przesuwanego dachu i boków.  
 This profile is primarily determined for sliding roof and sides.  
 Schiebeverdeck + Schiebeplane.*

## PROFILE PROWADZ CE CS FIX / GUIDING PROFILE CS FIX / DACHPROFILE CS FIX

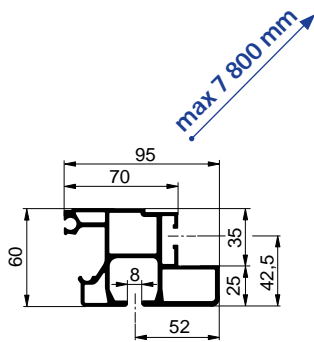

275CSF5000 - AI (5 000mm)  
 275CSF7800 - AI (7 800mm)



*Informacja techniczna / Technical information / Technische Informationen:  
 Profil prowadzący przeznaczony jest stałej konstrukcji dachu i przesuwanym boków.  
 This profile is primarily determined for fixed roof and sliding sides.  
 Festes Dach + Schiebeplane.*

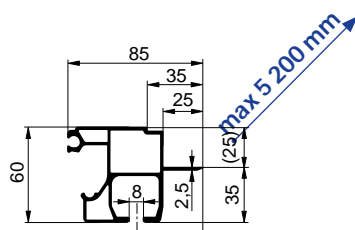

275CFM5200 - AI (7 800 mm)

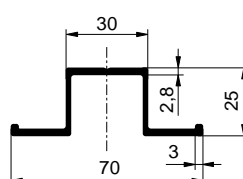

66L0014011 - AI

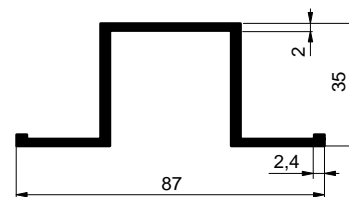

6600008043 - AI



2020/09/30



## SŁUPKI CS MAX PRZEDNIE I TYLNE / FRONT AND REAR PILLARS CS MAX / RUNGENPROFILE CS MAX

# CSMax

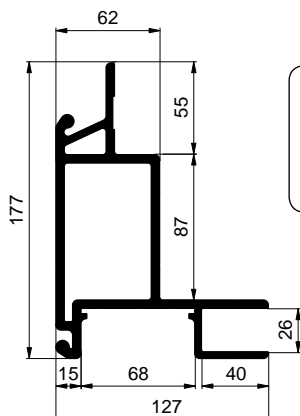

*Informacja techniczna / Technical information / Technische Informationen:  
 Aluminiowe słupki są dostarczane jako komplet razem z elementami montażowymi.  
 Mounting set is included in the Al pillars.  
 Al Rungen sind mit Montageteilen geliefert.*

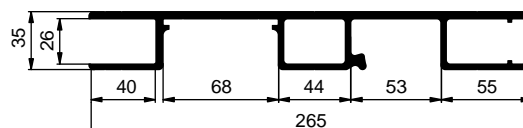

**66OAP17712 - Al (3 300mm)**  
**66OP177127 - elox/anoda (3 300mm)**

**66OAZ03526 - Al (3 300mm)**  
**66OZ035265 - elox/anoda (3 300mm)**

## SŁUPKI CS MIDI PRZEDNIE I TYLNE / FRONT AND REAR PILLARS CS MIDI / RUNGENPROFILE CS MIDI

# S MIDI

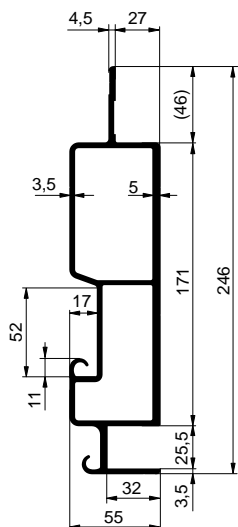

**66KA309800 - Al**  
**66KE309800 - elox/anoda**

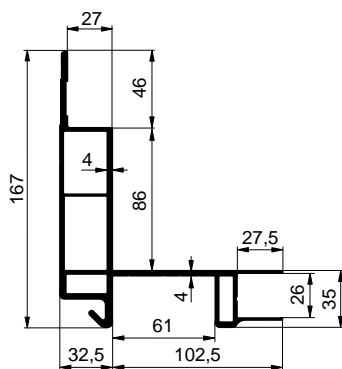

**66K0AP1090 - Al**  
**66K0EP1090 - elox/anoda**

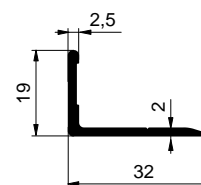

**66K0EU0820 - elox/anoda**

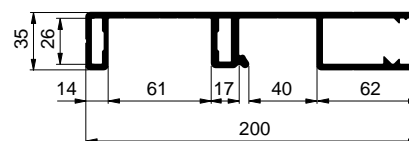

**66K0AZ2000 - Al**  
**66K0EZ2000 - elox/anoda**

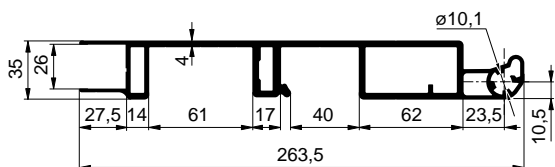

**6600013865 - Al**  
**6612013865 - elox/anoda**

[www.alu-sv.com](http://www.alu-sv.com)

SŁUPKI CS MINI PRZEDNIE I TYLNE / FRONT AND REAR PILLARS CS MINI /  
RUNGENPROFILE CS MINI

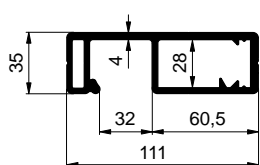

66K0EZ1110 - elox/anoda

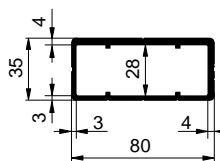

66K0EU0800 - elox/anoda

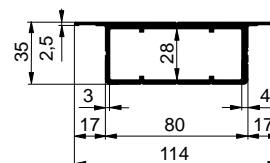

66K0EU0810 - elox/anoda

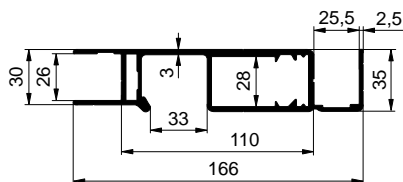

6600013554 - AI  
« 6612013554 - elox/  
anoda

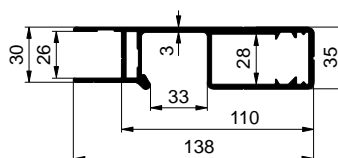

6600013555 - AI  
« 6612013555 - elox/  
anoda

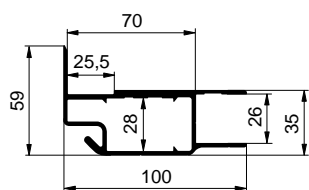

6600013575 - AI  
6612013575 - elox/anoda

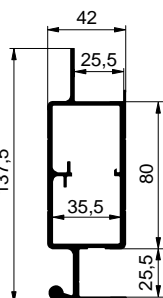

6600013576 - AI  
6612013576 - elox/anoda

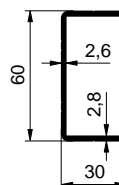

6600012891 - AI  
6612012891 - elox/anoda

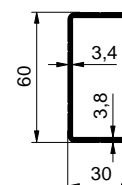

6600310377 - AI

ALUMINIOWY PORTAL ECO / ALUMINIUM PORTAL ECO / ALUMINIUM PORTAL ECO

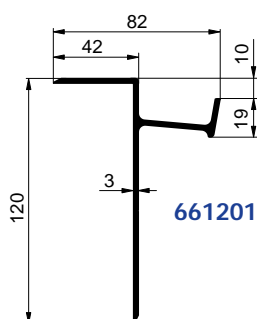

6612013366 - AI

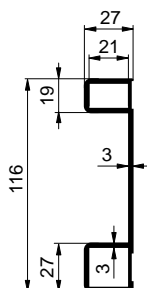

6600013365 - AI

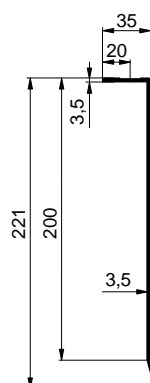

6600111085 - AI  
6612111085 - elox/anoda

ALUMINIOWY TYLNY PORTAL / ALUMINIUM REAR PORTAL / ALUMINIUM HECKPORTAL

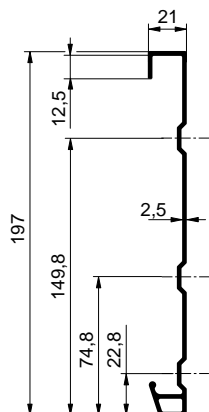

6600310517 - AI

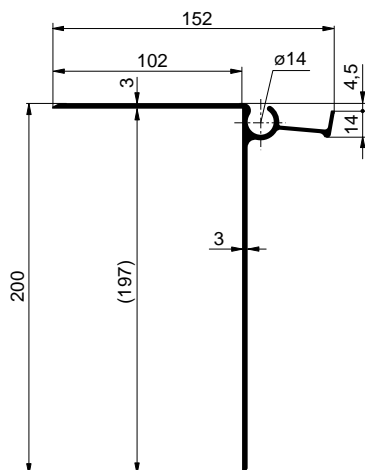

6612111720 - elox/anoda

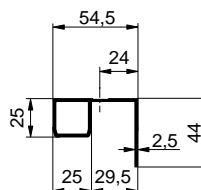

6612310518 - elox/anoda



2020/09/30



# PROFILE DO ZACZEPIANIA I NAPINANIA PLANDEKI / TARPAULIN TENSIONERS / PLANENSPANNER, ANFAHRSCHUTZPROFIL

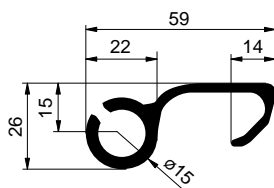
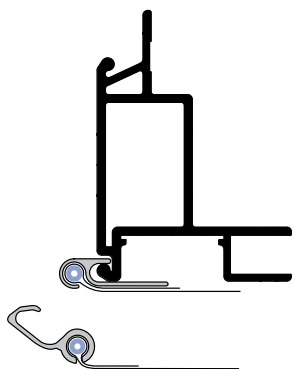

7209999204 - AI

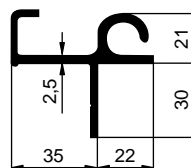

4311037400 - AI

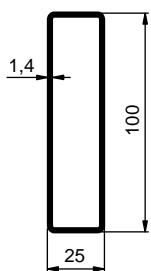

6600012232 - AI  
6612012232 - elox/anoda

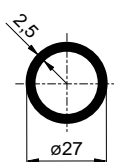

6600100230 - AI

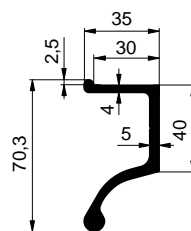

6600010415 - AI

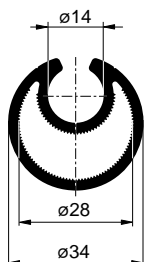
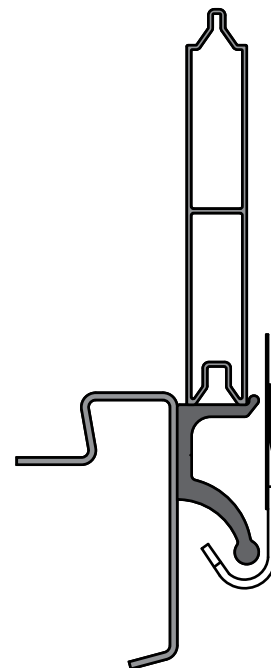

7R00334034 - AI

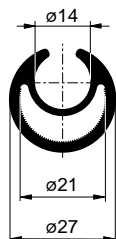

7R00310027 - AI (3 100mm)  
7R00330027 - AI (3 300mm)

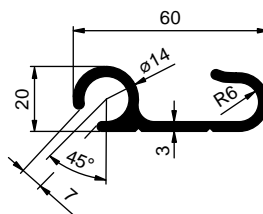

4311024500 - AI

6600013701 - AI »  
6612013701 - elox/anoda

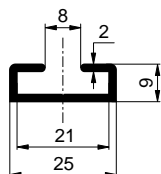

7R00013557 - AI (2 550mm)  
7R00113557 - AI (3 100mm)  
7R00213557 - AI (3 300mm) »

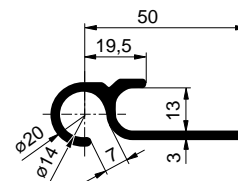

## PROFILE DRZWI TYLNYCH / ALUMINIUM REAR DOOR / HECKTÜREN

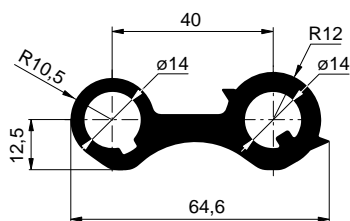

66VEP13440 - elox/anoda

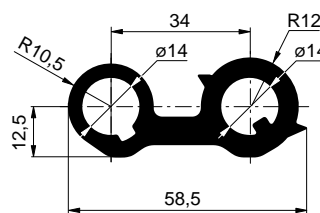

66VEP13439 - elox/anoda

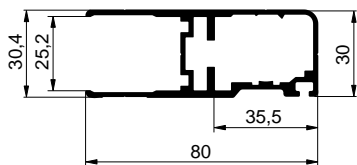

**66VA012967 - AI**  
**66V0012967 - elox/anoda**

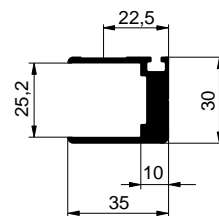

**6612111497 - elox/anoda**

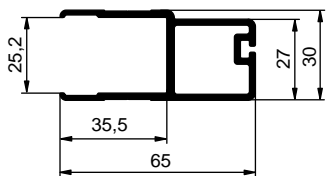

**66VAL00650 - AI**  
**66VEL00650 - elox/anoda**

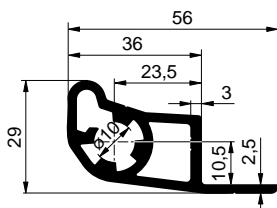

**66VEZ12274 - elox/anoda**

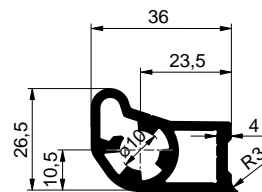

**66VEZ13601 - elox/anoda**



**62VT100912**



**62VT101425**



**62VT201428**



**62VT410000**

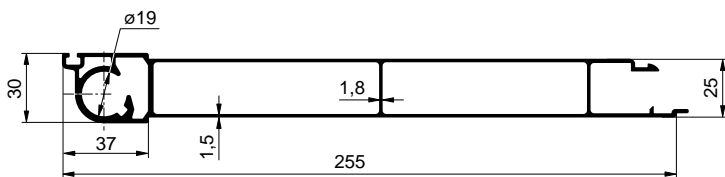

**66VAV13438 - AI**  
**66VEV13438 - elox/anoda**



**62VT300000**

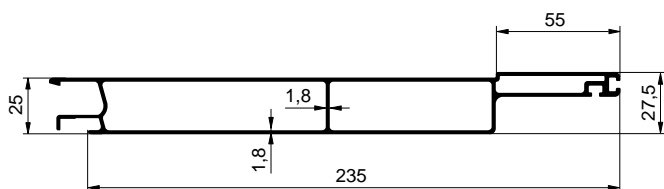

**66VAV13977 - AI**  
**66VEV13977 - elox/anoda**

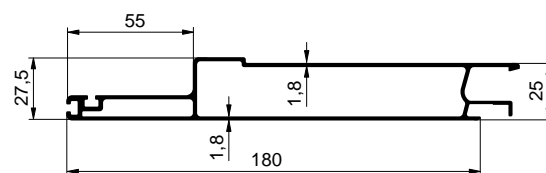

**66VAV13978 - AI**  
**66VEV13978 - elox/anoda**

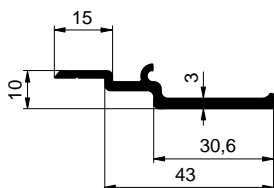

**66VA012969 - AI**  
**66V0012969 - elox/anoda**

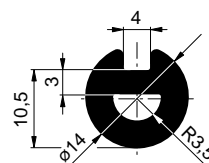

**66VAP00140 - AI**



# ALUMIOWE PROFILE KONTENERA / BOX TYPE BODIES / KOFFERAUFBAUTEN

## ALUMIOWE PROFILE RAMY / ALUMINIUM FRAME / AUSSENRAHMENPROFILE FÜR KOFFER

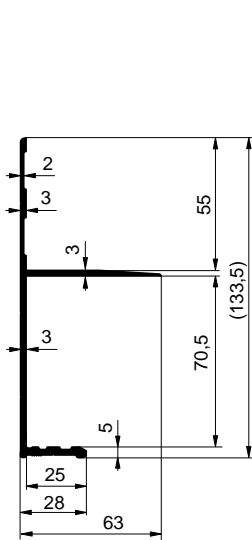

6600012416 - AI  
6612012416 - elox/anoda

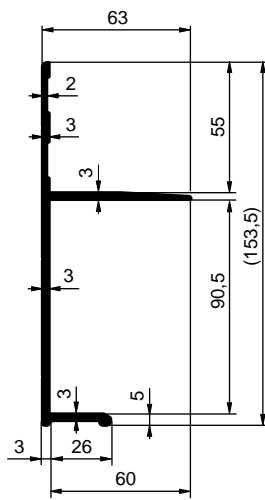

6600012415 - AI  
6612012415 - elox/anoda

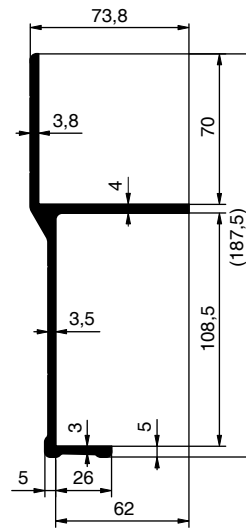

6600007971 - AI  
6612007971 - elox/anoda

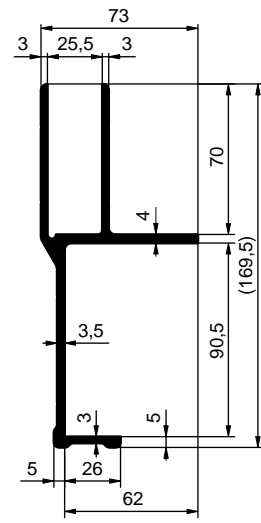

6612008491 - elox/anoda

## ALUMIOWE PROFILE DRZWI / ALUMINIUM DOOR ARCAL / ALUMINIUM TÜREN ARCAL

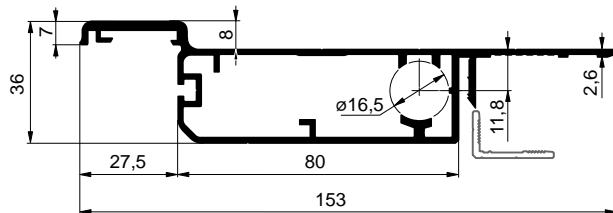

66L2012495 - elox/anoda

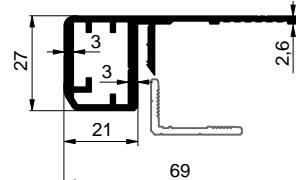

66L2012496 - elox/anoda

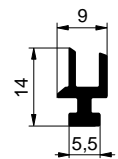

1001009680

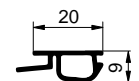

1001009681

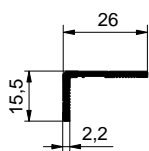

66L2011791 - elox/anoda

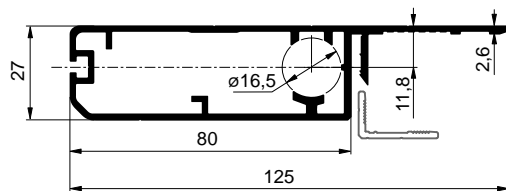

66L2013820 - elox/anoda

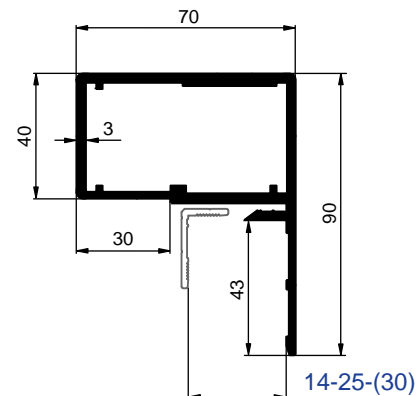

66L0012234 - AI  
66L2012234 - elox/anoda

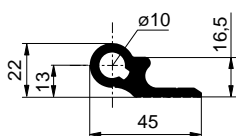

6612012948 - elox/anoda

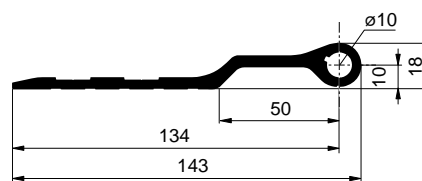

6612012950 - elox/anoda

KONTENER PLYWOOD / PLYWOOD BOX / PLYWOOD KOFFER

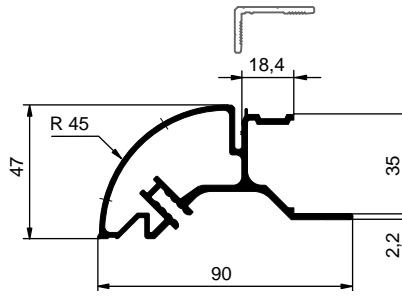

66L2011794 - elox/anoda

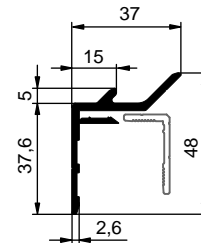

66L2011790 - elox/anoda

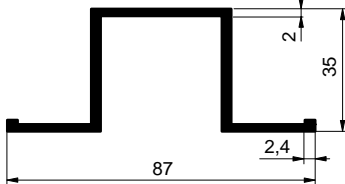

6600008043 - Al

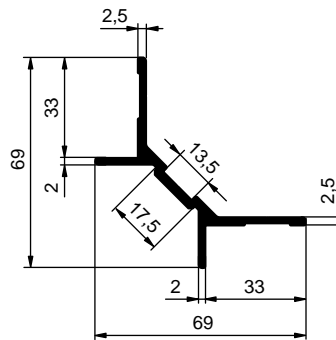

66L0011793 - Al

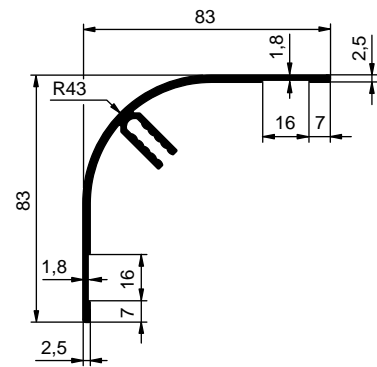

66L2011792 - elox/anoda

POZOSTALE ALUMINIOWE PROFILE KONTENERA / ALUMINIUM BOX PROFILES / SONSTIGE ALUMINIUM-PROFILE FÜR KOFFER

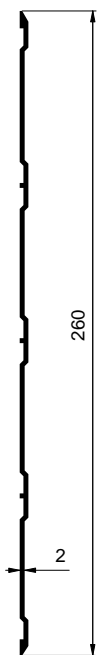

6600007460 - Al  
6612007460 - elox/anoda

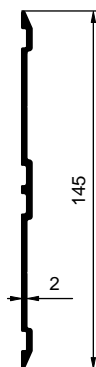

6600012382 - Al

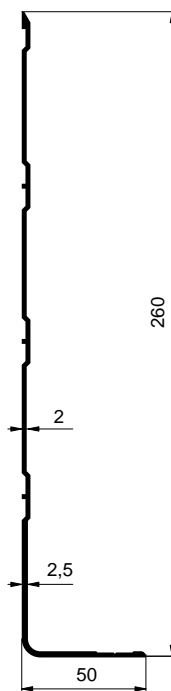

6600007461 - Al

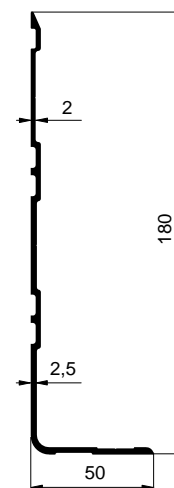

6600012383 - Al

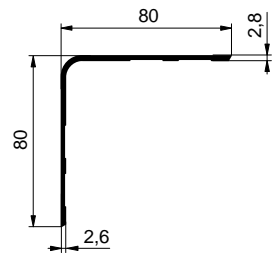

6600007752 - Al  
6612007752 - elox/anoda

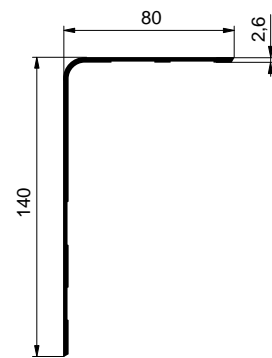

6600008090 - Al  
6612008090 - elox/anoda



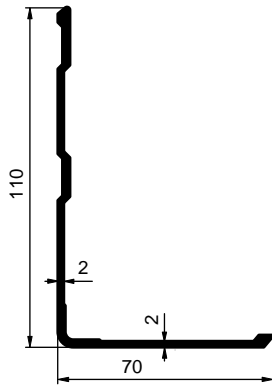

6600008087 - AI  
6612008087 - elox/anoda

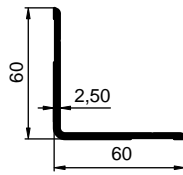

6600007767 - AI  
6612007767 - elox/anoda

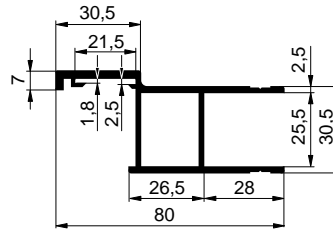

6612008066 - elox/anoda

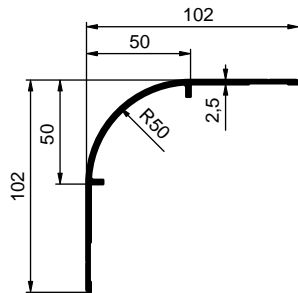

1000006817 - AI  
1000068171 - elox/anoda

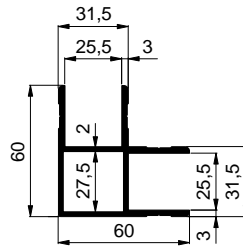

6600007870 - AI  
6612007870 - elox/anoda

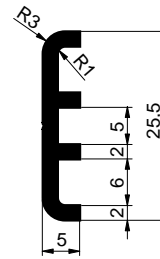

4153600100 - AI

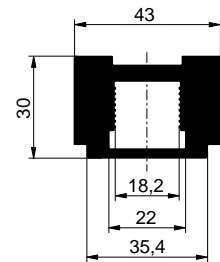

6600013296 - AI

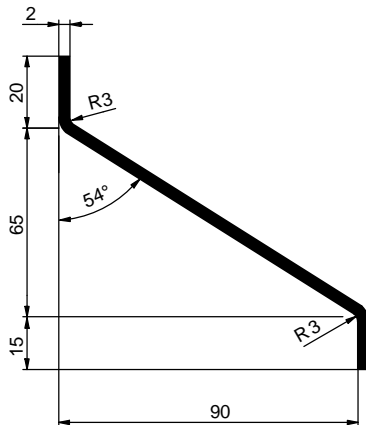

62800PLY01 - AI (RAL 9007)

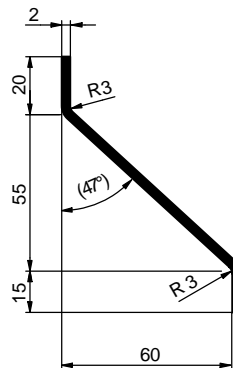

62800PLY00 - AI (RAL 9007)

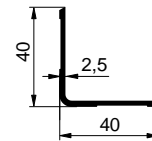

6600007768 - AI  
6612007768 - elox/anoda

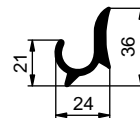

6612003176 - elox/anoda

### OSŁONA PRZECIWNIAJZDOWA / SIDE PROTECTION / SEITLICHER ANFAHRSCHUTZ

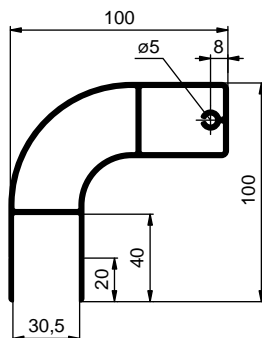

6600010382 - AI  
6612010382 - elox/anoda

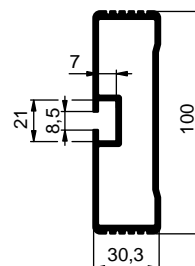

6600012231 - AI  
6612012231 - elox/anoda

# ELEMENTY PODŁOGOWE / PARTS FOR ALUMINIUM FLOOR / ALUMINIUM BODEN

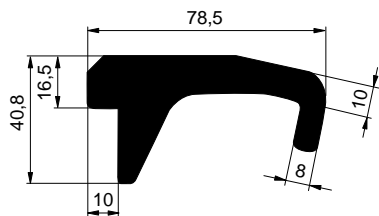

100CH04750 - AI

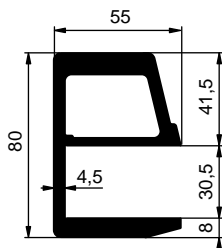

6600012233 - AI

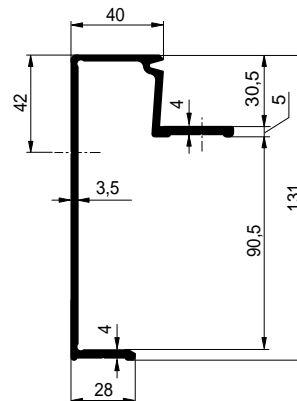
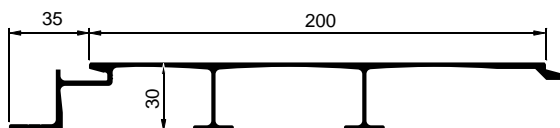
 6600014024 - AI  
6612014024 - elox

6600641032 - AI

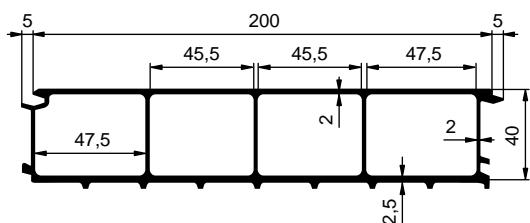

6600008544 - AI

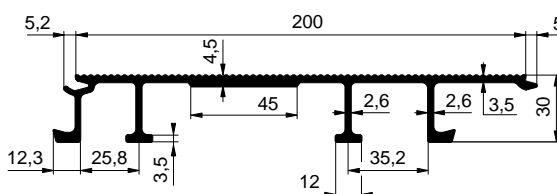

6600013491 - AI

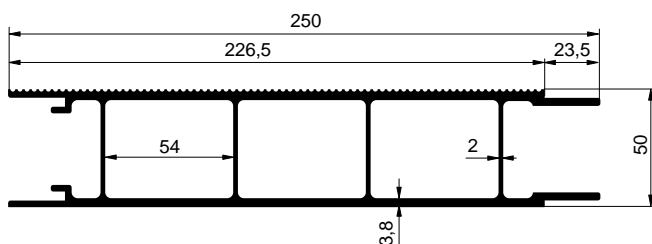

6600013324 - AI

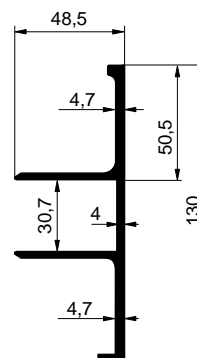

6600013492 - AI



2020/09/30



# PRZEJAZDY / LOADING RAMP / ÜBERFAHRBRÜCKE

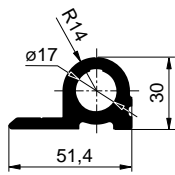

6600013763 - Al

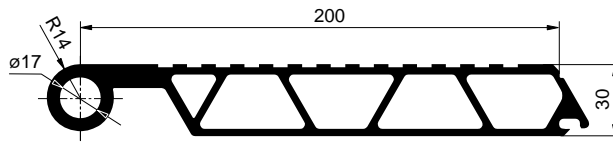

6600013764 - Al

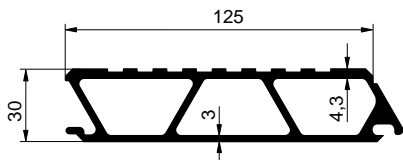

6600013765 - Al

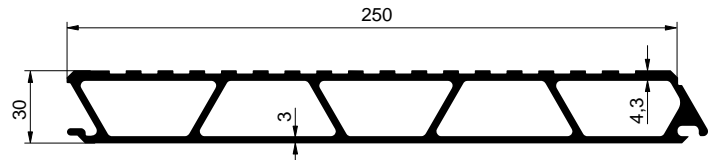

6600013766 - Al

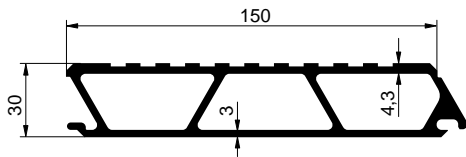

6600013768 - Al

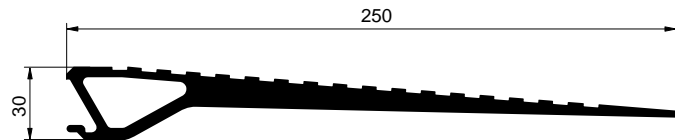

6600013767 - Al

# INNE / OTHER / SONSTIGES

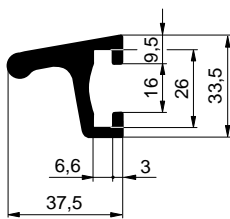

2200071094 - Al

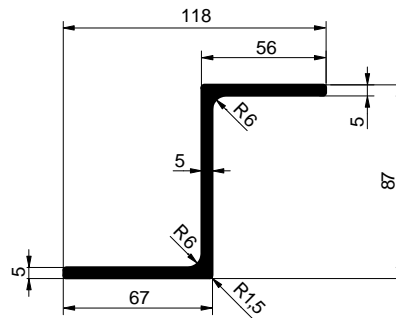

6600013436 - Al

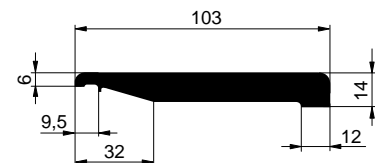

6600013442 - Al

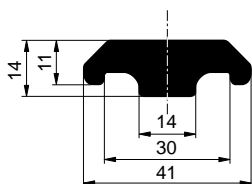

6600007775 - Al

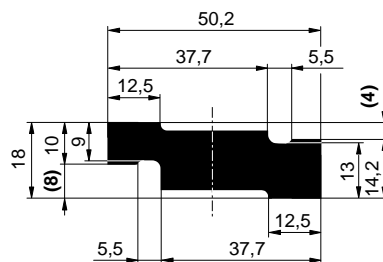

6600007776 - Al

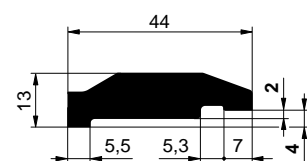

6600013456 - Al

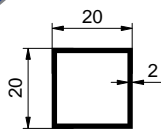

F100100244 - AI

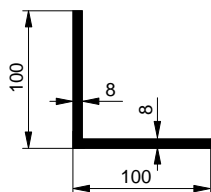

F101042892 - AI

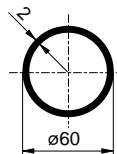

F100100330- AI

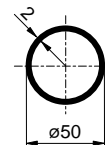

F100101316- AI

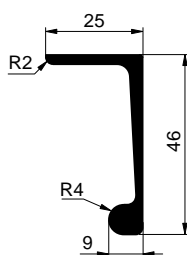

6600111228 - AI